

OB1 - <offline>

"Main Program"

Name:
Author:
Time stamp Code:
Interface:
Lengths (block/logic/data): 00688 00524 00034

Family:
Version: 0.1
Block version: 2
 21-09-2011 14:37:45
 21-09-2011 10:13:11

| Address | Declaration | Name | Type | Initial value | Comment |
|---------|-------------|------------------|---------------|---------------|---|
| 0.0 | temp | OB1_EV_CLASS | BYTE | | Bits 0-3 = 1 (Coming event), Bits 4-7 = 1 (Event class 1) |
| 1.0 | temp | OB1_SCAN_1 | BYTE | | 1 (Cold restart scan 1 of OB 1), 3 (Scan 2-n of OB 1) |
| 2.0 | temp | OB1_PRIORITY | BYTE | | Priority of OB Execution |
| 3.0 | temp | OB1_OB_NUMBR | BYTE | | 1 (Organization block 1, OB1) |
| 4.0 | temp | OB1_RESERVED_1 | BYTE | | Reserved for system |
| 5.0 | temp | OB1_RESERVED_2 | BYTE | | Reserved for system |
| 6.0 | temp | OB1_PREV_CYCLE | INT | | Cycle time of previous OB1 scan (milliseconds) |
| 8.0 | temp | OB1_MIN_CYCLE | INT | | Minimum cycle time of OB1 (milliseconds) |
| 10.0 | temp | OB1_MAX_CYCLE | INT | | Maximum cycle time of OB1 (milliseconds) |
| 12.0 | temp | OB1_DATE_TIME | DATE_AND_TIME | | Date and time OB1 started |
| 20.0 | temp | USER_ID | INT | | Memoriza o ID do utilizador actual |
| 22.0 | temp | UA_SELECTED | INT | | Memoriza a UA seleccionada |
| 24.0 | temp | M_USER_NOT_EXIST | BOOL | | |
| 26.0 | temp | MTIMETEMP | TIME | | v temp |
| 30.0 | temp | M_END | BOOL | | |
| 30.1 | temp | M_SEARCH_ID | BOOL | | |
| 30.2 | temp | M_SEARCH_EMPTY | BOOL | | |
| 30.3 | temp | M_SYSTEM_FULL | BOOL | | |
| 30.4 | temp | M1 | BOOL | | |
| 30.5 | temp | RESET | BOOL | | |

Block: OB1 "Main Program Sweep (Cycle)"

Network: 1 START

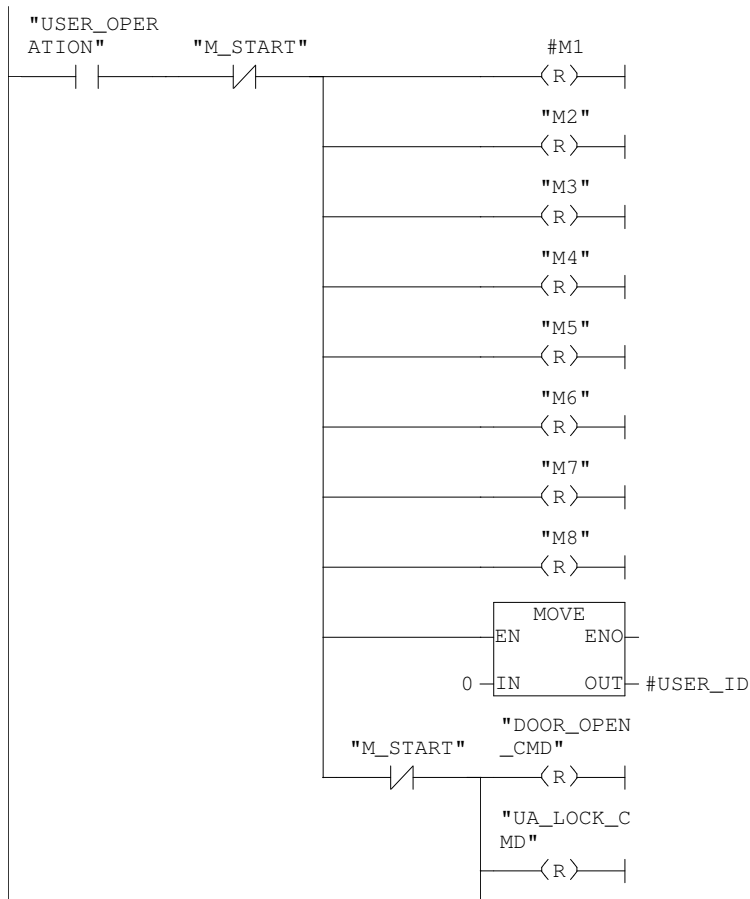

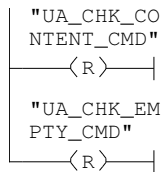
**Symbol information**

| | | |
|--------|--------------------|--|
| I126.0 | USER_OPERATION | Comando Utilizador operacao de entrega/recolha |
| M2.0 | M_START | |
| M1.1 | M2 | |
| M1.2 | M3 | |
| M1.3 | M4 | |
| M1.4 | M5 | |
| M1.5 | M6 | |
| M1.6 | M7 | |
| M1.7 | M8 | |
| Q124.0 | DOOR_OPEN_CMD | Comando de Abertura das Portas |
| Q125.7 | UA_LOCK_CMD | Bloqueia a UA na plataforma do elevador |
| Q125.6 | UA_CHK_CONTENT_CMD | Comanda a verificacao do interior da UA |
| Q124.5 | UA_CHK_EMPTY_CMD | Comanda a verificacao para detectar se a UA esta vazia |

Network: 2 RESET

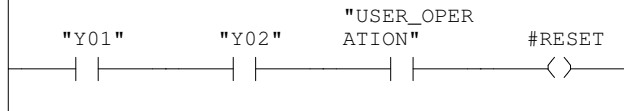
**Symbol information**

| | | |
|--------|----------------|--|
| I126.2 | Y01 | Posicao de transporte 1 |
| I126.3 | Y02 | Posicao de transporte 2 |
| I126.0 | USER_OPERATION | Comando Utilizador operacao de entrega/recolha |

Network: 3 Controla a variavel de processo M_START

Ao serem pressionados simultaneamente os contactos Y01 e Y02 é feito um reset a variavel M_START

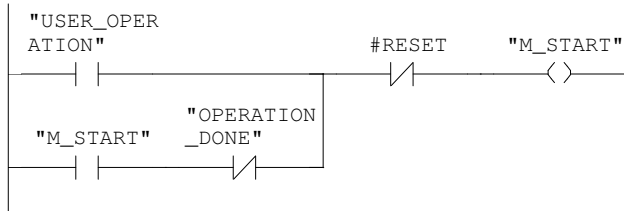
**Symbol information**

| | | |
|--------|----------------|--|
| I126.0 | USER_OPERATION | Comando Utilizador operacao de entrega/recolha |
| M2.0 | M_START | |
| Q124.7 | OPERATION_DONE | Operacao terminada com sucesso |

Network: 4 Inicia o processo

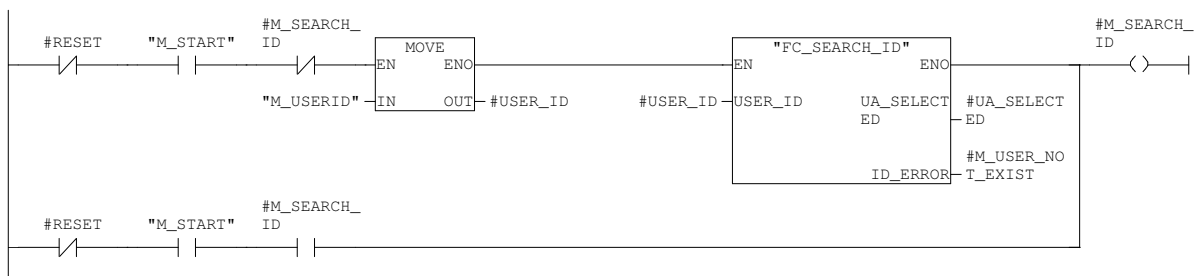

Symbol information

M2.0 M_START
 MW50 M_USERID User ID do leitor de cartoes
 FC4 FC_SEARCH_ID Procura a UA associada ao ID

Network: 5

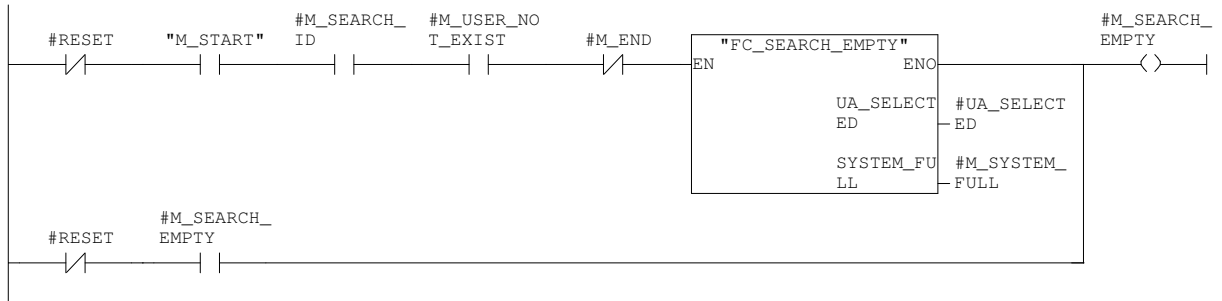
**Symbol information**

M2.0 M_START
 FC3 FC_SEARCH_EMPTY Procura uma UA vazia

Network: 6

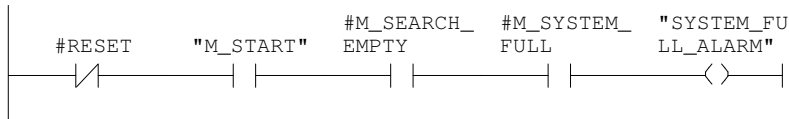
**Symbol information**

M2.0 M_START
 Q124.4 SYSTEM_FULL_ALARM Lotacao Esgotada

Network: 7

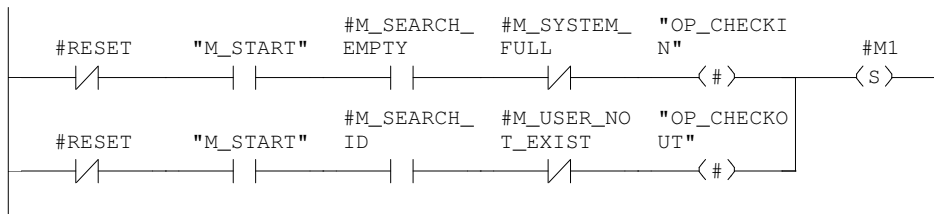
**Symbol information**

M2.0 M_START
 M50.5 OP_CHECKIN
 M50.6 OP_CHECKOUT

Network: 8

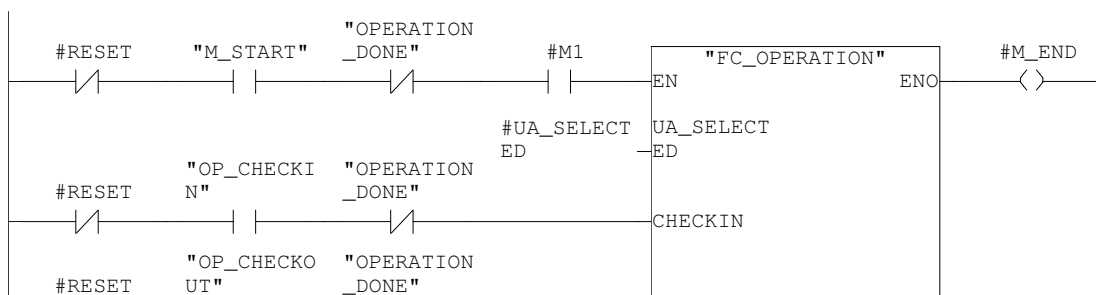

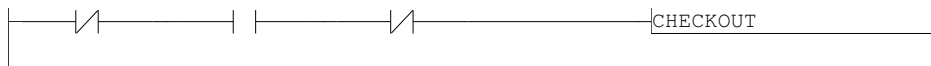
**Symbol information**

| | | |
|--------|----------------|--|
| M2.0 | M_START | |
| Q124.7 | OPERATION_DONE | Operacao terminada com sucesso |
| M50.5 | OP_CHECKIN | |
| M50.6 | OP_CHECKOUT | |
| FC9 | FC_OPERATION | Cordena a operacao de checkin checkout |

| | |
|------------|-----|
| Network: 9 | END |
|------------|-----|

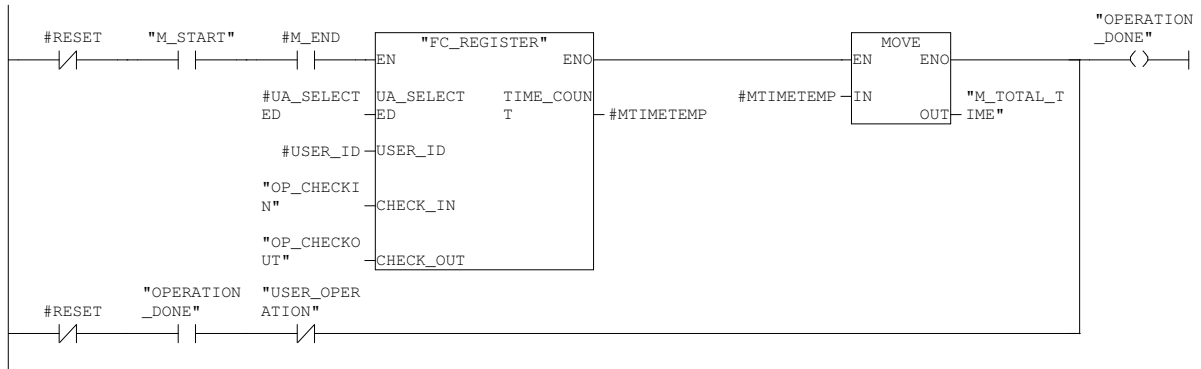
**Symbol information**

| | | |
|--------|----------------|--|
| M2.0 | M_START | |
| FC8 | FC_REGISTER | Regista a operacao de check-in/check-out |
| M50.5 | OP_CHECKIN | |
| M50.6 | OP_CHECKOUT | |
| MW51 | M_TOTAL_TIME | Totaliza o tempo de uso do sistema |
| Q124.7 | OPERATION_DONE | Operacao terminada com sucesso |
| I126.0 | USER_OPERATION | Comando Utilizador operacao de entrega/recolha |