

SCALE = 1:77

UNITS: kN

DATE:10-11-11

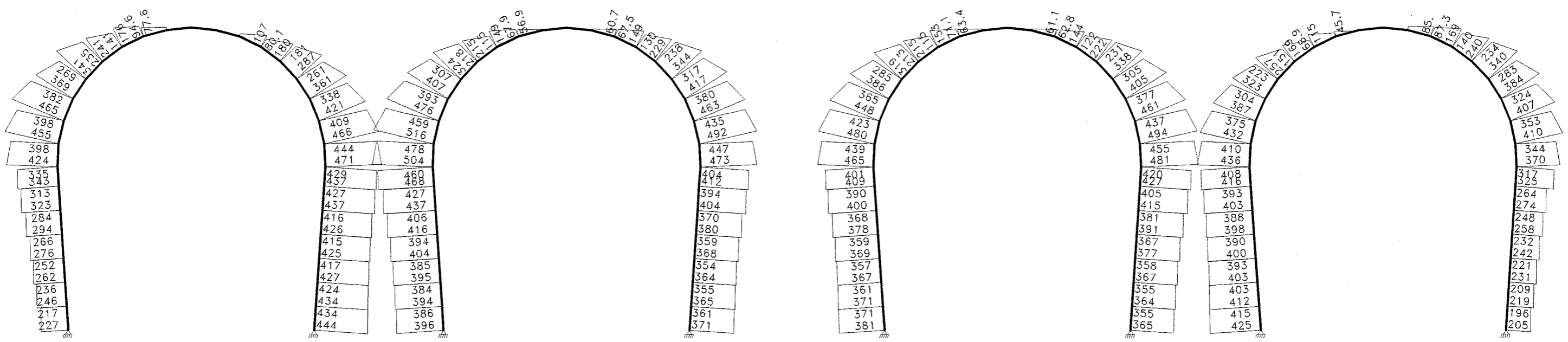

AXIAL FORCE COMB. NO. 1 Combinao ELU1

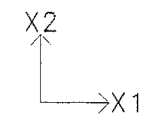

SCALE = 1:77

UNITS: kN

DATE:10-11-11

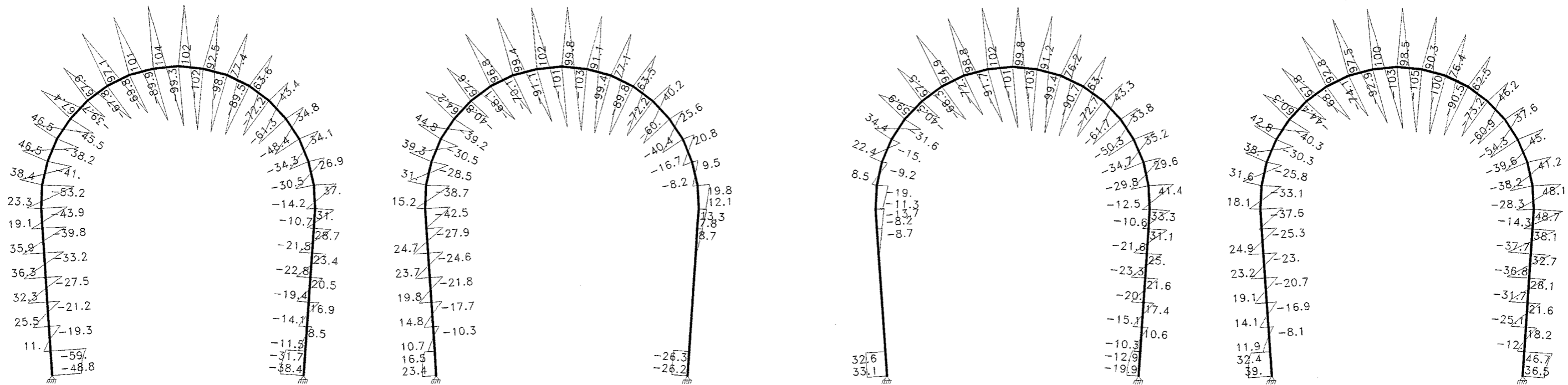

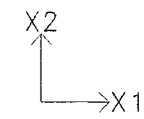

SCALE = 1:77

UNITS: kN*m

DATE:10-11-11

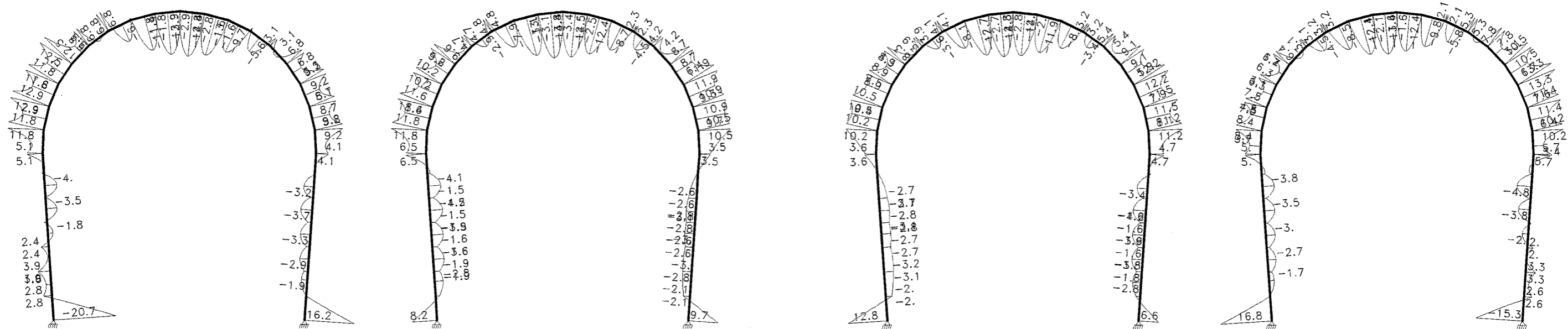

M3 MOMENT COMB. NO. 1 Combinac ELU1

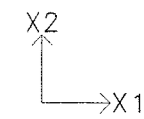

SCALE = 1:77

UNITS: kN

DATE:10-11-11

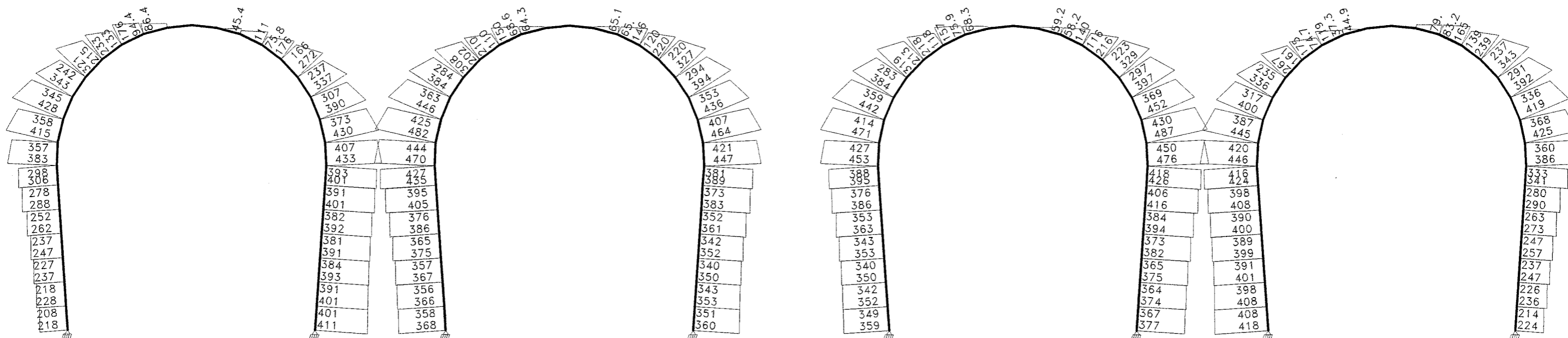

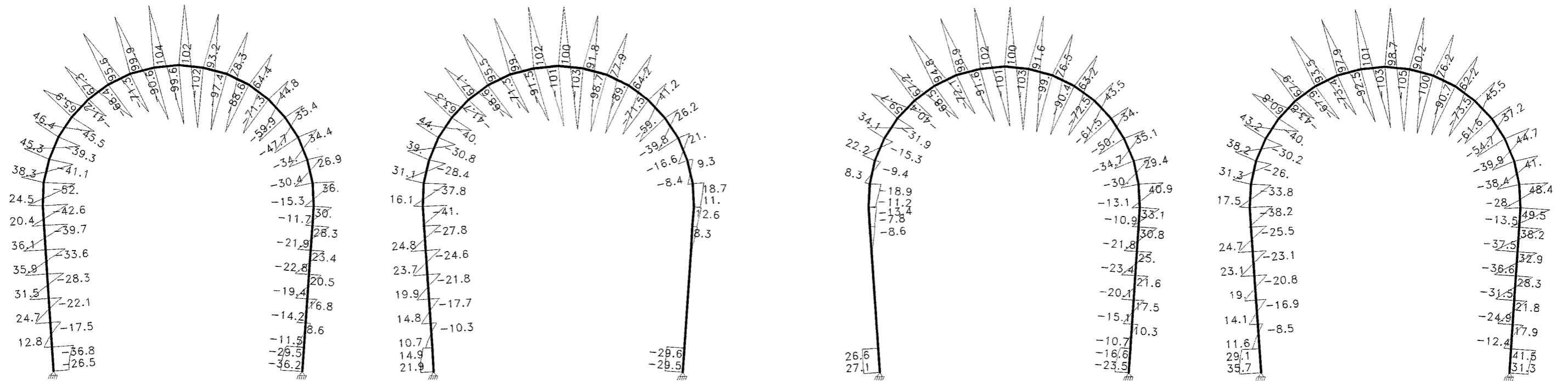

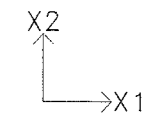

SCALE = 1:77

UNITS: kN*m

DATE:10-11-11

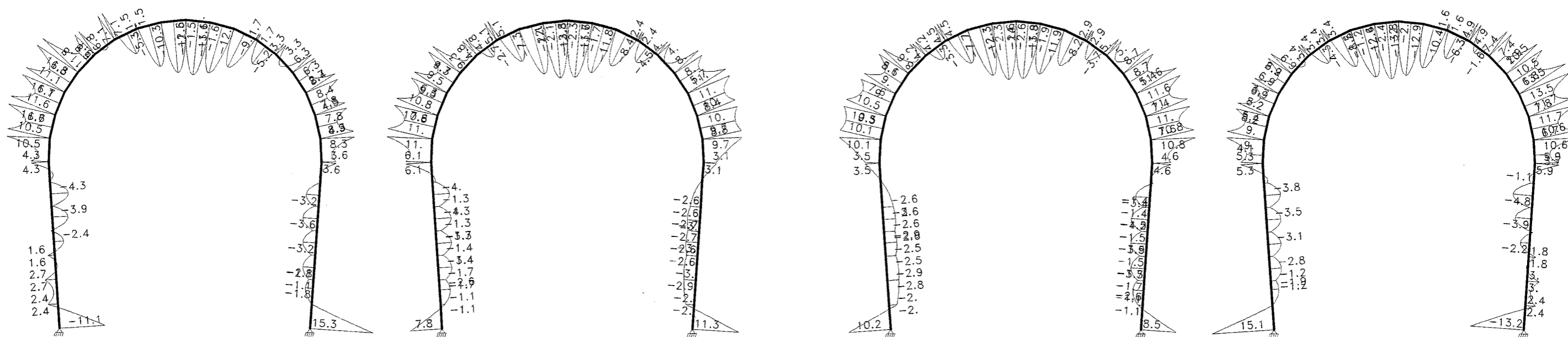

M3 MOMENT

COMB. NO. 2 Combinao ELU2

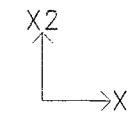

SCALE = 1:77

UNITS: kN

DATE:10-11-11

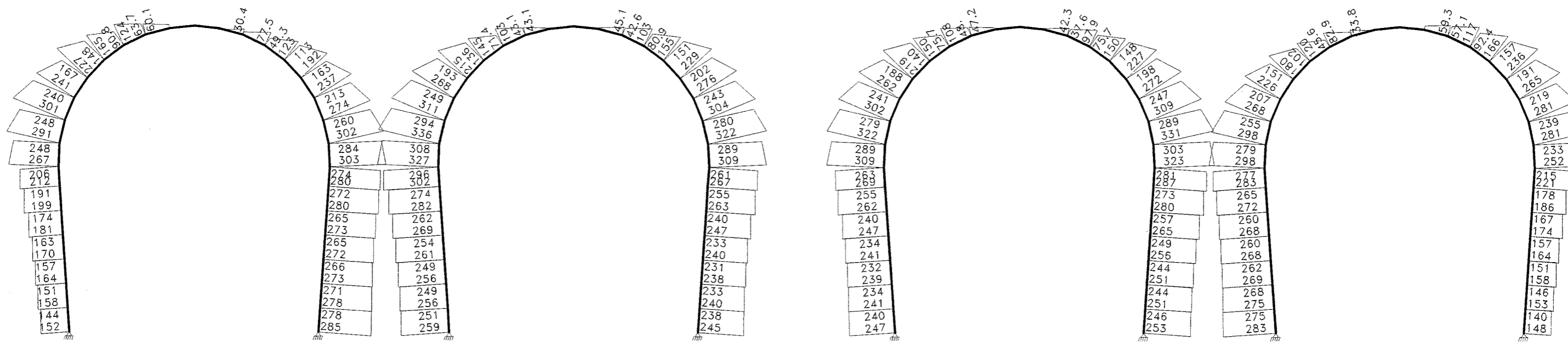

AXIAL FORCE COMB. NO. 3 Combinao FREQUENTE1

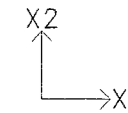

SCALE = 1:77

UNITS: kN

DATE:10-11-11

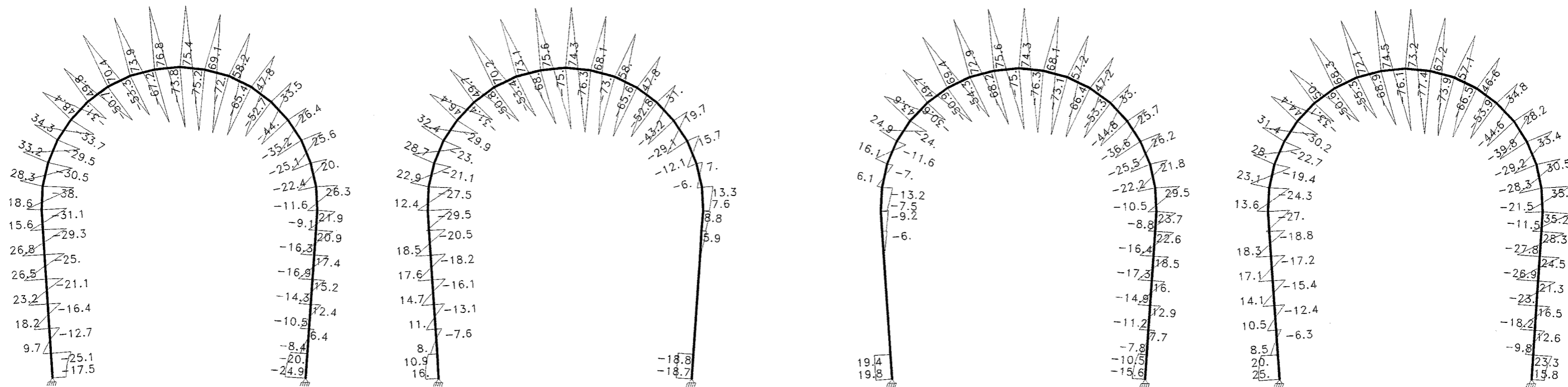

V2 SHEAR

COMB. NO. 3 Combinado FREQUENTE1

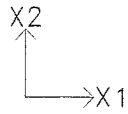

SCALE = 1:77

UNITS: kN*m

DATE:10-11-11

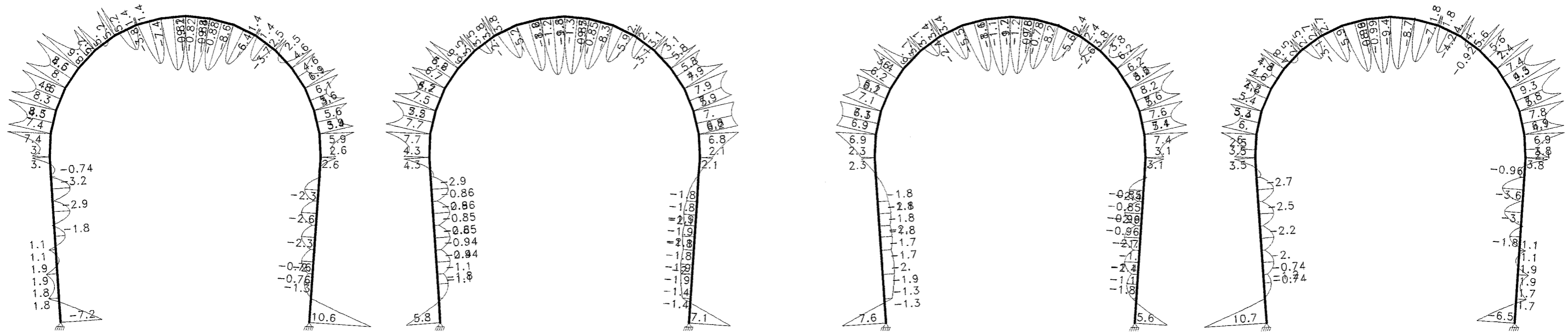

M3 MOMENT

COMB. NO. 3 Combinao FREQUENTE1

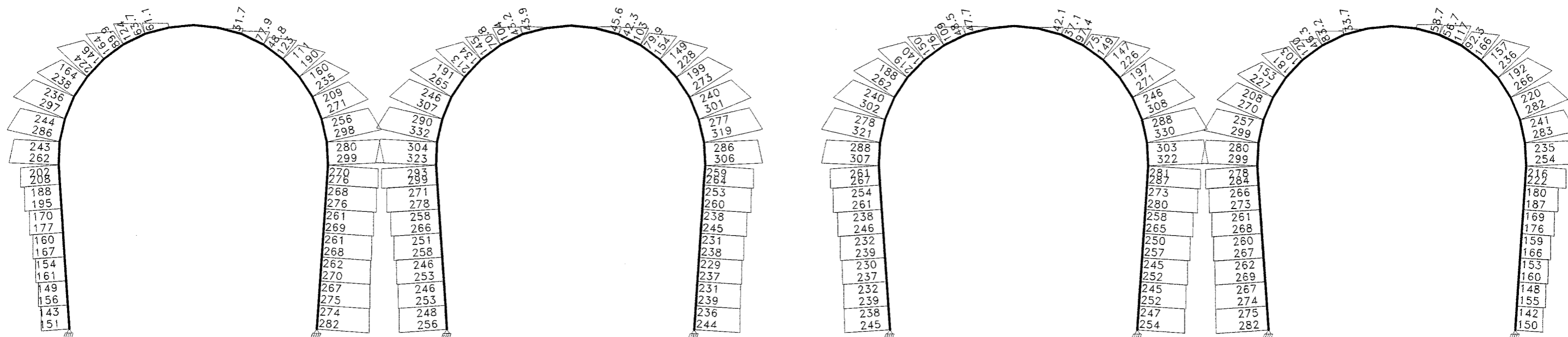
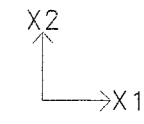

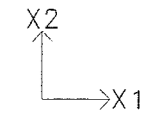

SCALE = 1:77

UNITS: kN

DATE:10-11-11

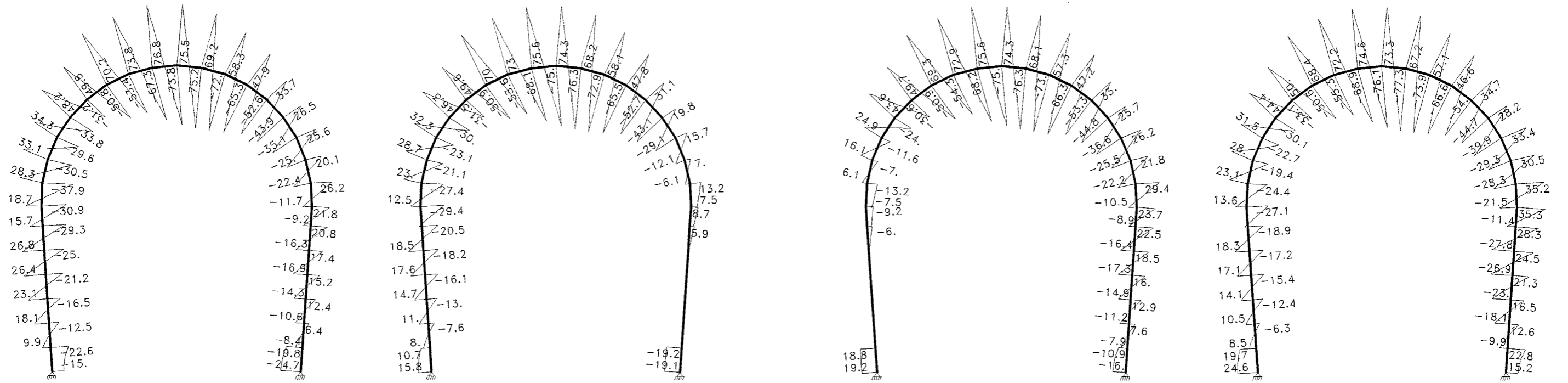

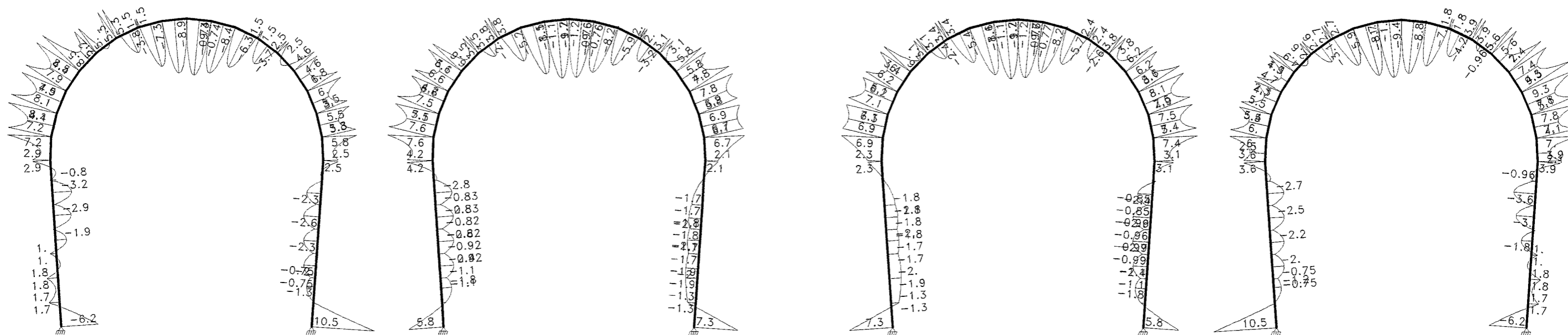
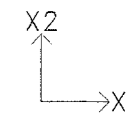

M3 MOMENT

COMB. NO. 4 Combinao FREQUENTE2

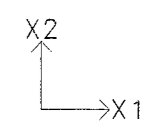

SCALE = 1:77

UNITS: kN

DATE:10-11-11

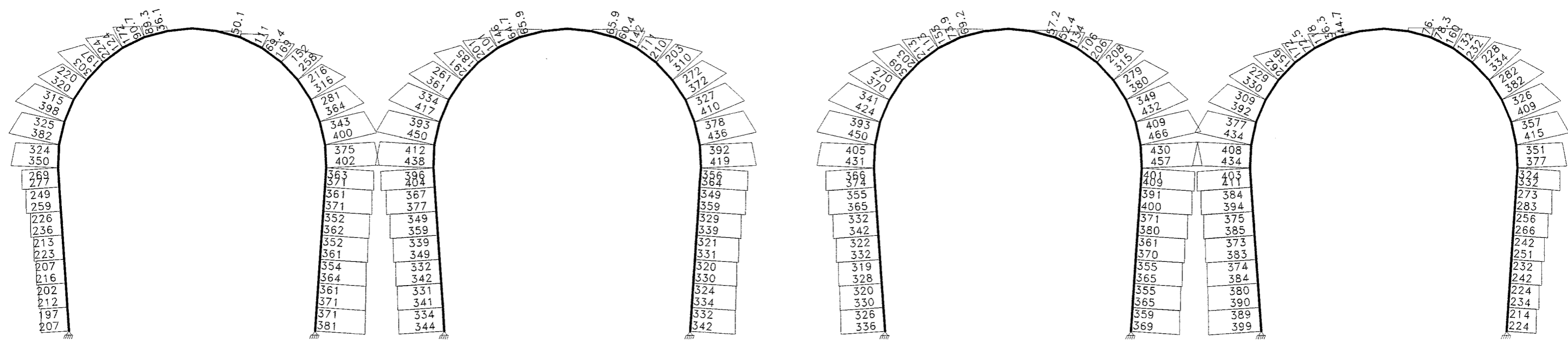

AXIAL FORCE COMB. NO. 5 Combinao ELU1 sem hotel

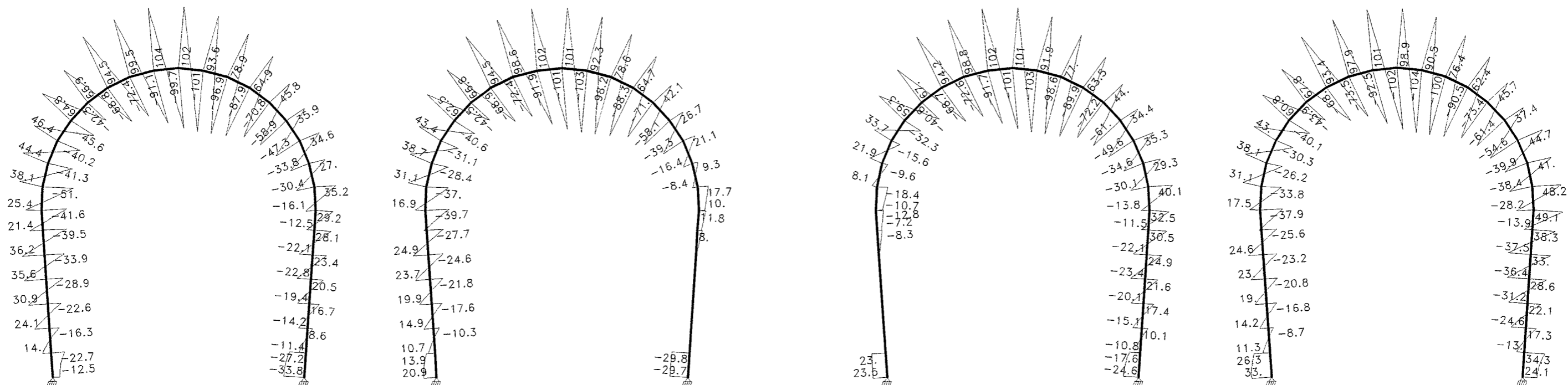

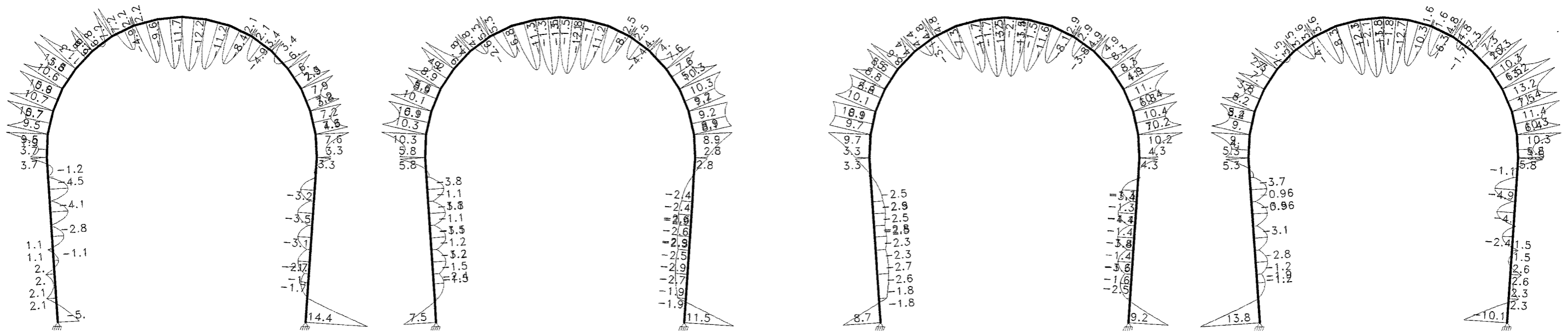
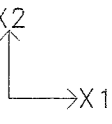

M3 MOMENT

COMB. NO. 5 Combinao ELU1 sem hotel

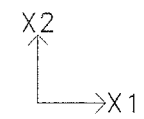

SCALE = 1:77

UNITS: kN

DATE:10-11-11

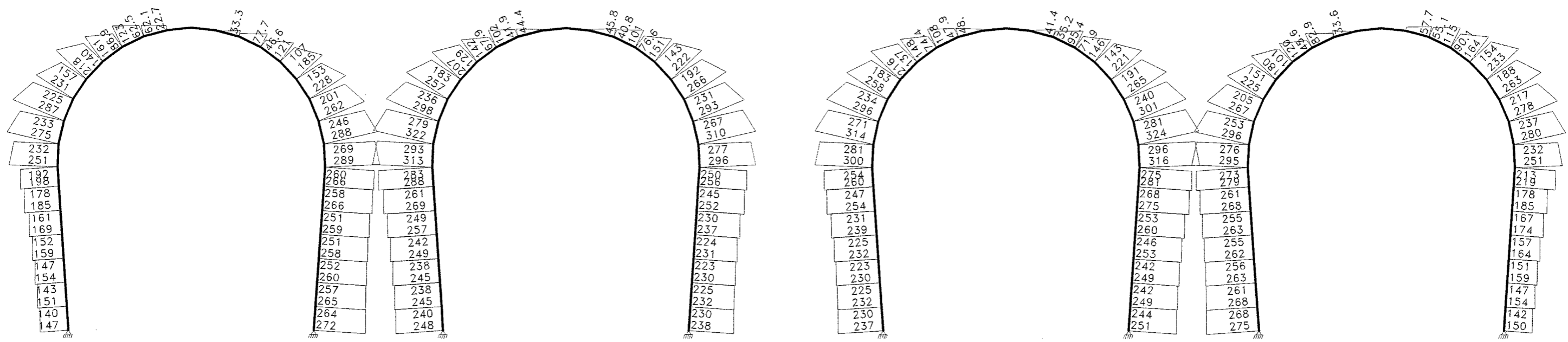

AXIAL FORCE COMB. NO. 6 Combinao FREQUENTE1 sem hotel

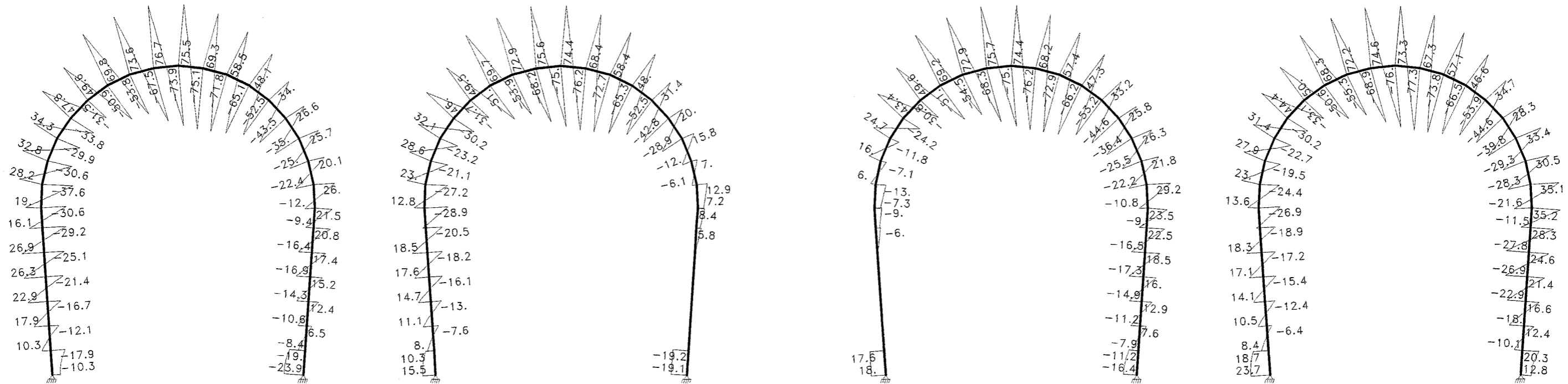
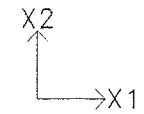

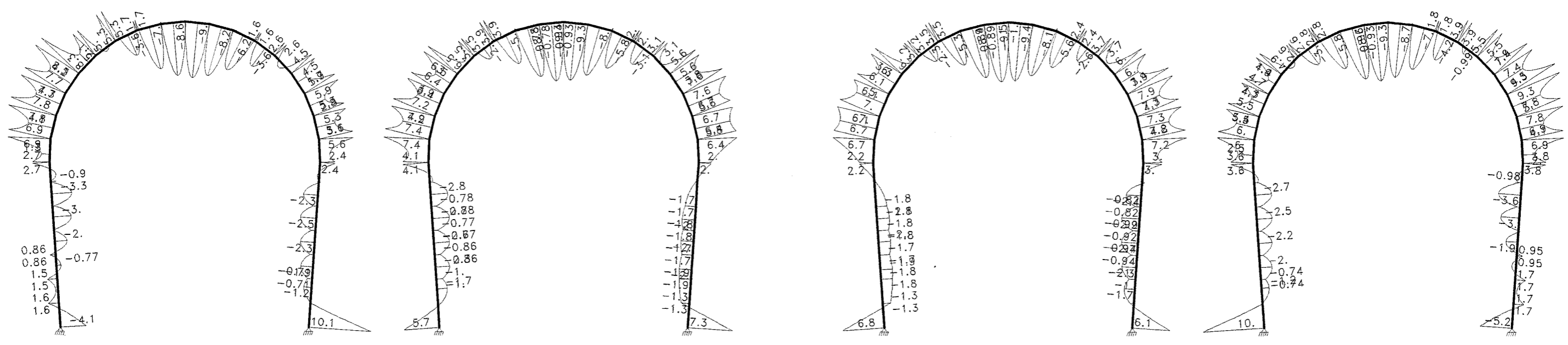
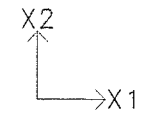

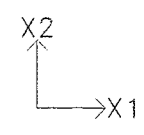

SCALE = 1:77

UNITS: meter

DATE:10-11-11

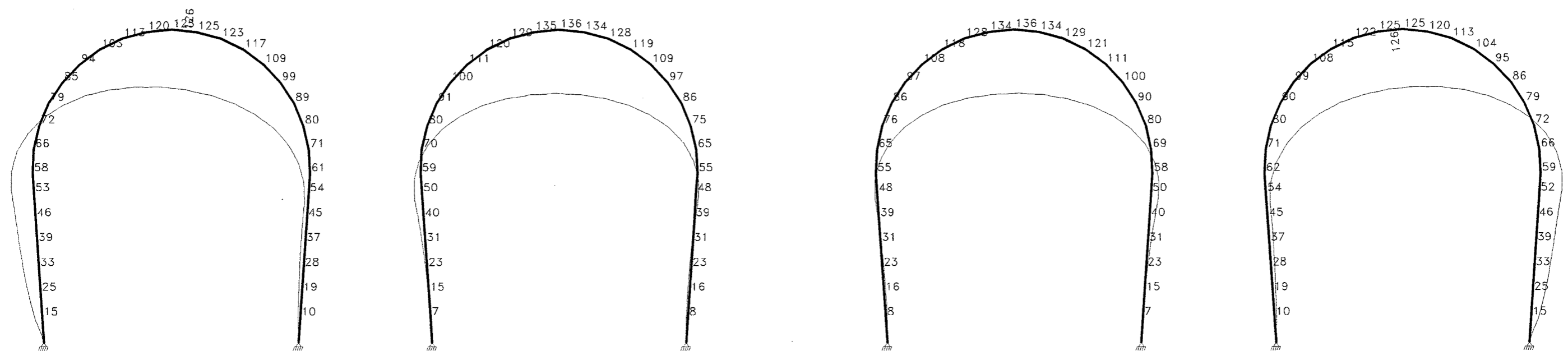

VALUES ARE * 10⁻⁶
DISPLACEMENTS LOAD NO. 1 P.P. Terreno

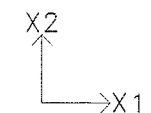

SCALE = 1:77

UNITS: meter

DATE:10-11-11

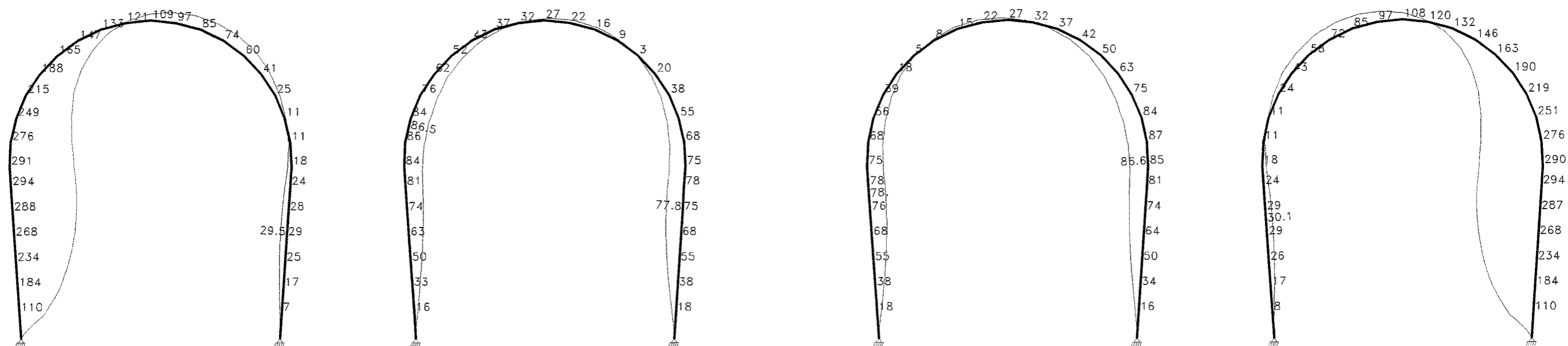

VALUES ARE * 10⁻⁹
DISPLACEMENTS LOAD NO. 2 Carga Unitria

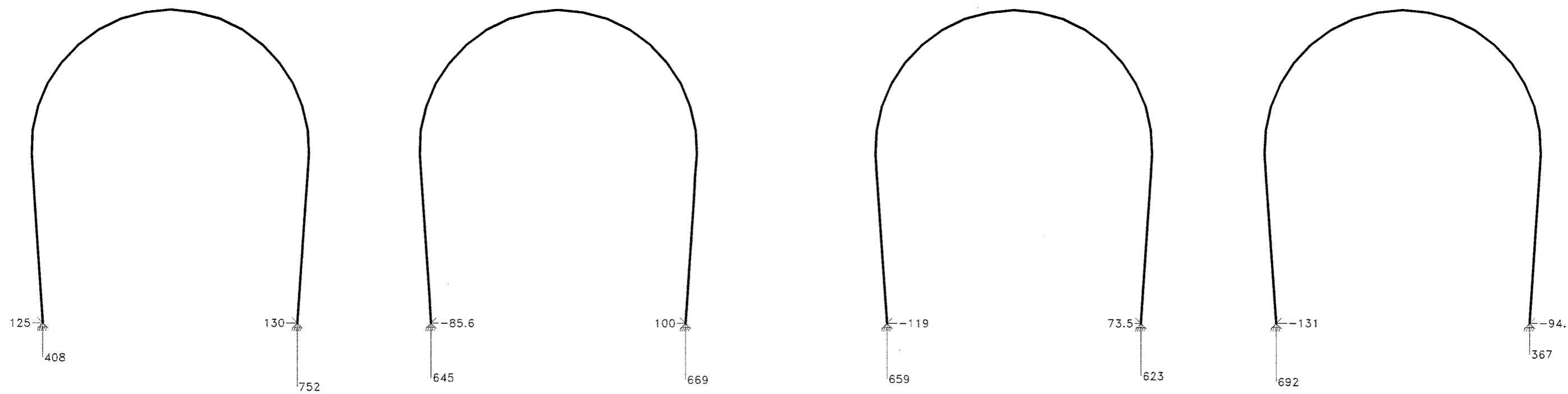
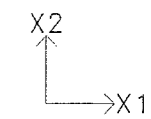

REACTIONS COMB. NO. 1 Combinao ELU1

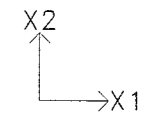

SCALE = 1:77

UNITS: kN

DATE:10-11-11

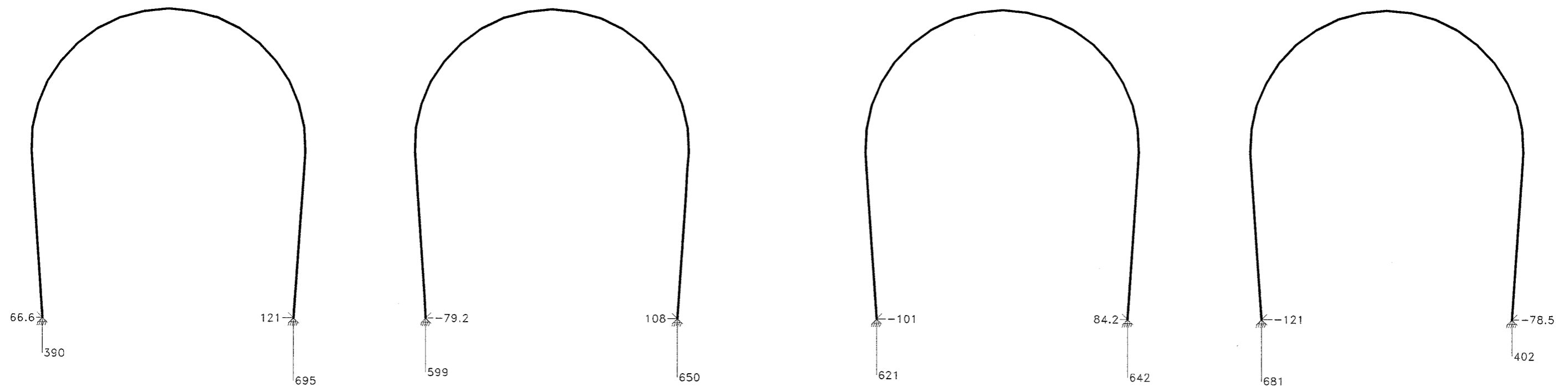

REACTIONS COMB. NO. 2 Combinao ELU2

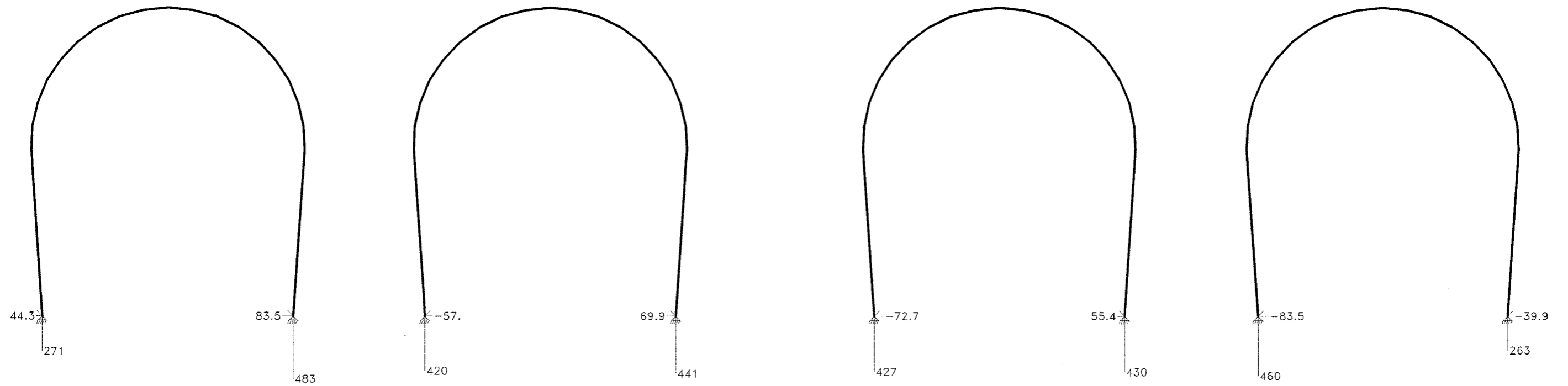
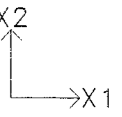

REACTIONS COMB. NO. 3 Combinao FREQUENTE1

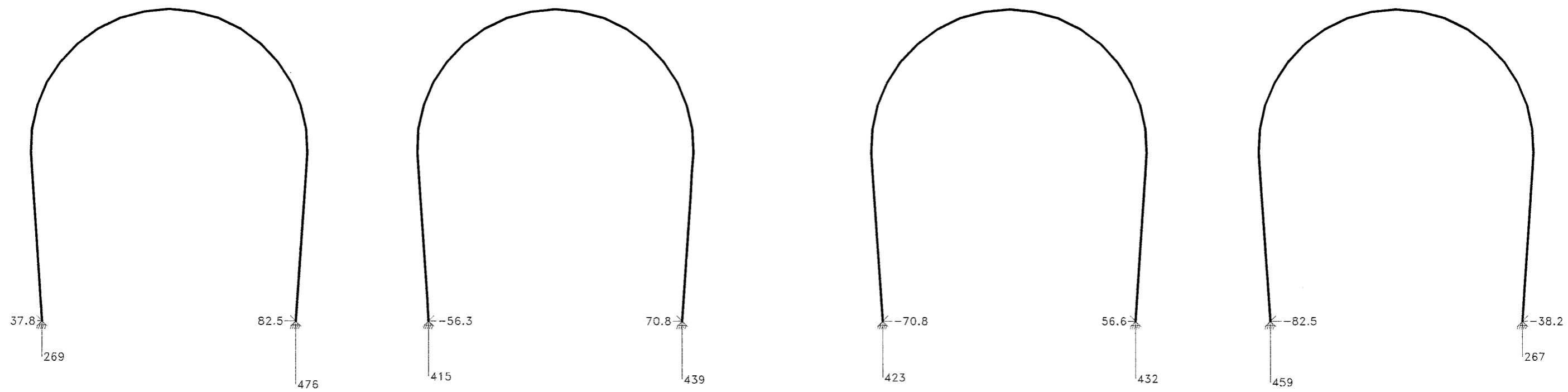
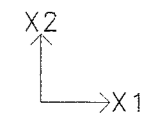

REACTIONS COMB. NO. 4 Combinao FREQUENTE2

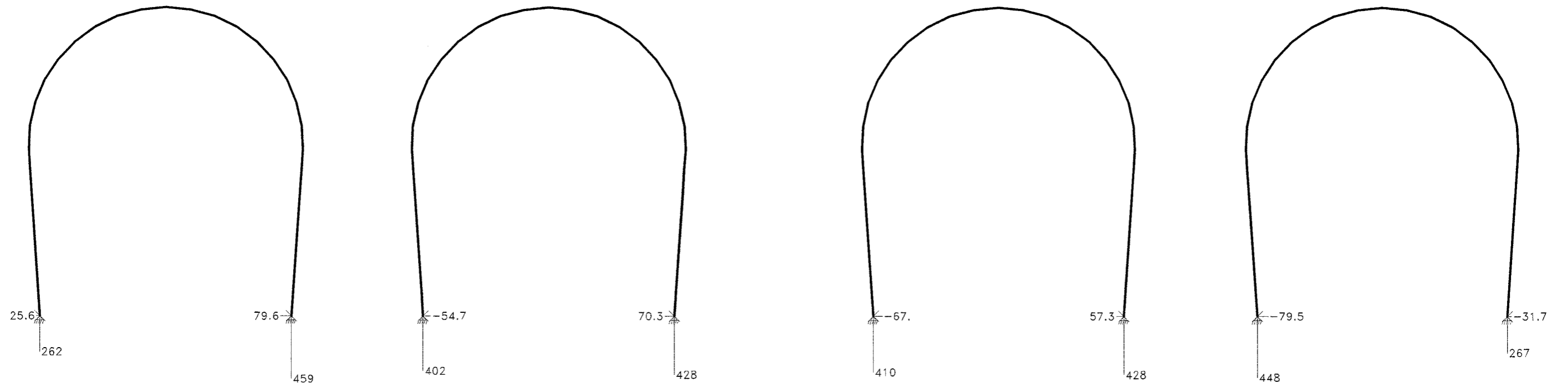
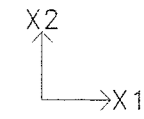

REACTIONS COMB. NO. 6 Combinao FREQUENTE1 sem hotel

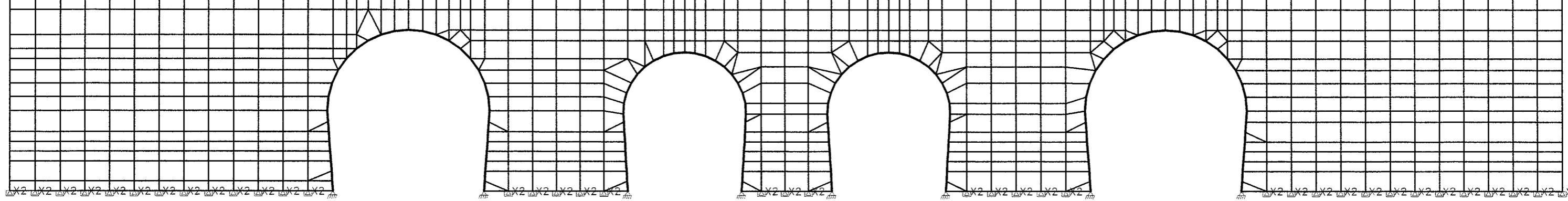
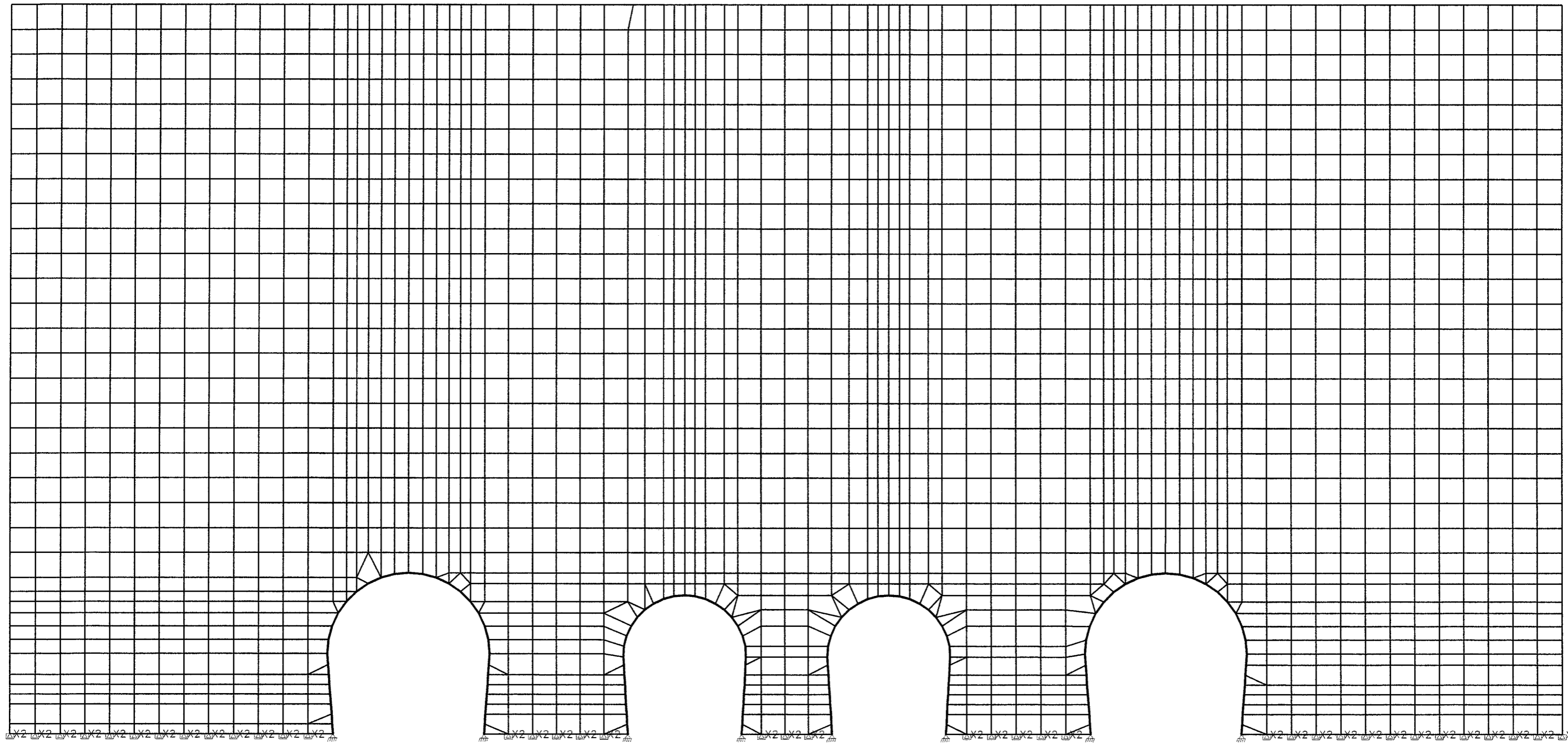
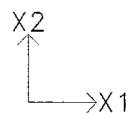

GEOMETRY

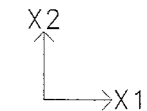

SCALE = 1:104

UNITS: kN

DATE:10-11-11

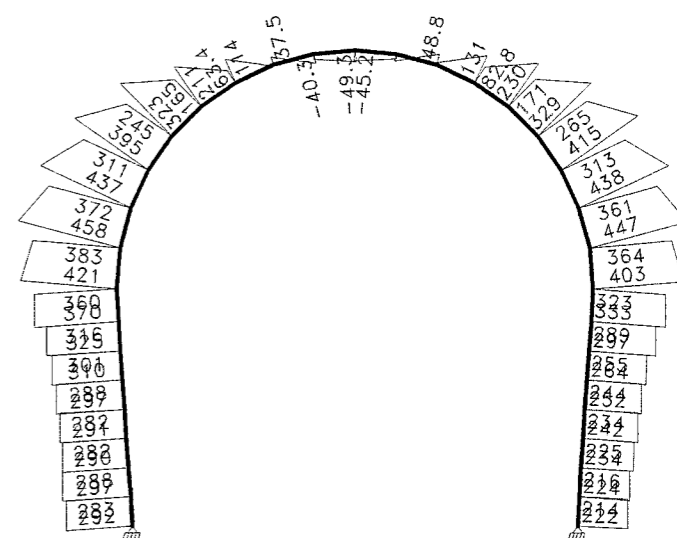
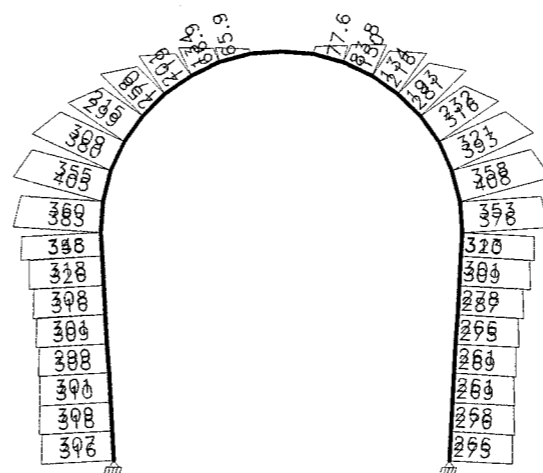
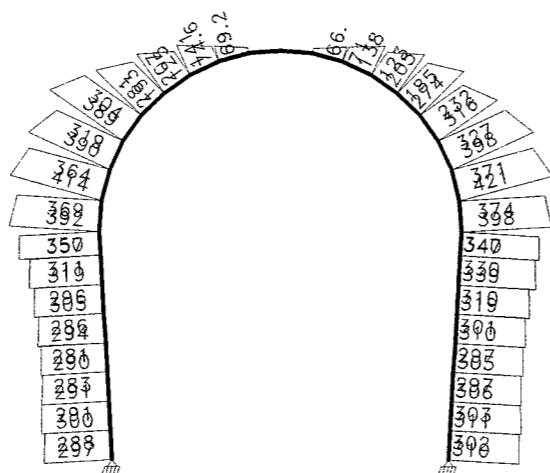
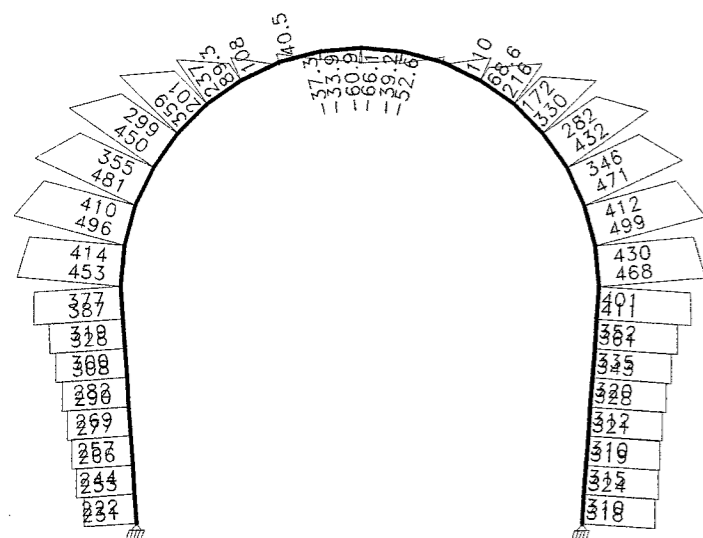

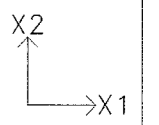

SCALE = 1:104

UNITS: kN

DATE:10-11-11

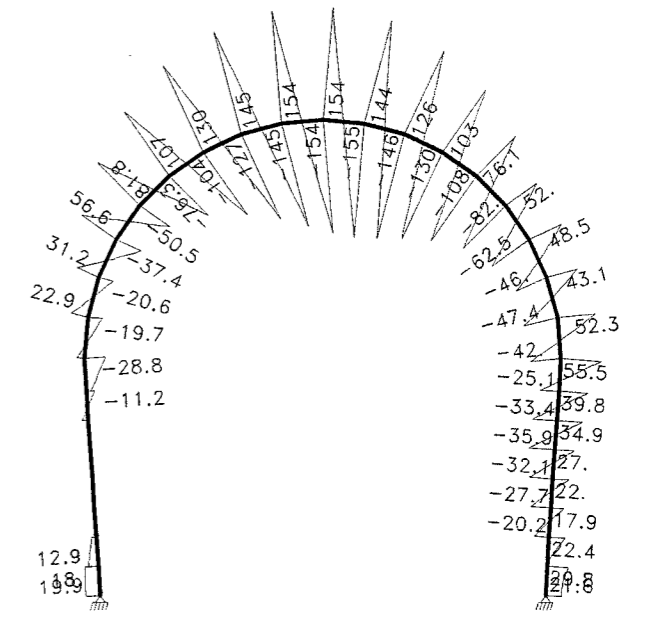
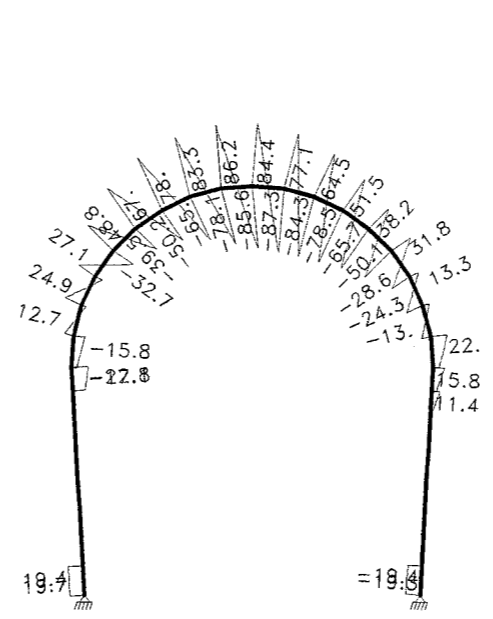
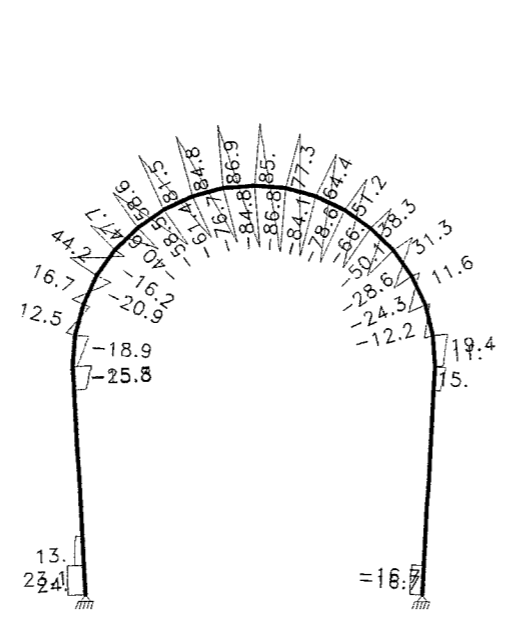
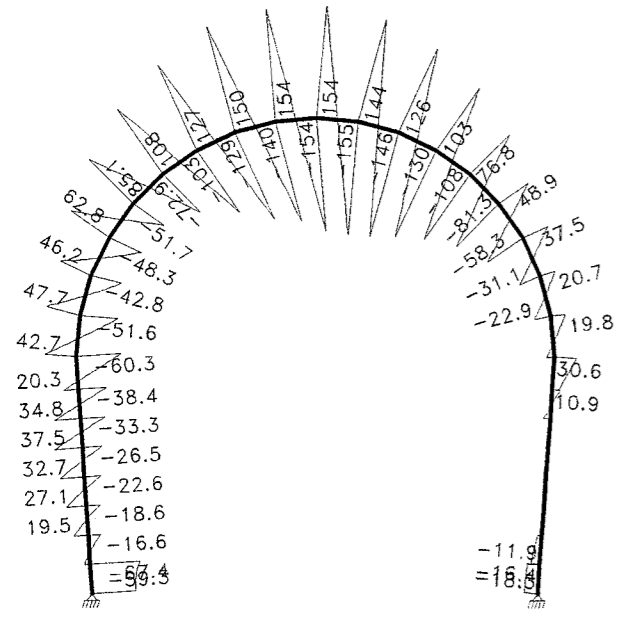

V2 SHEAR COMB. NO. 1 Combinco ELU1

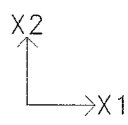

SCALE = 1:104

UNITS: kN*m

DATE:10-11-11

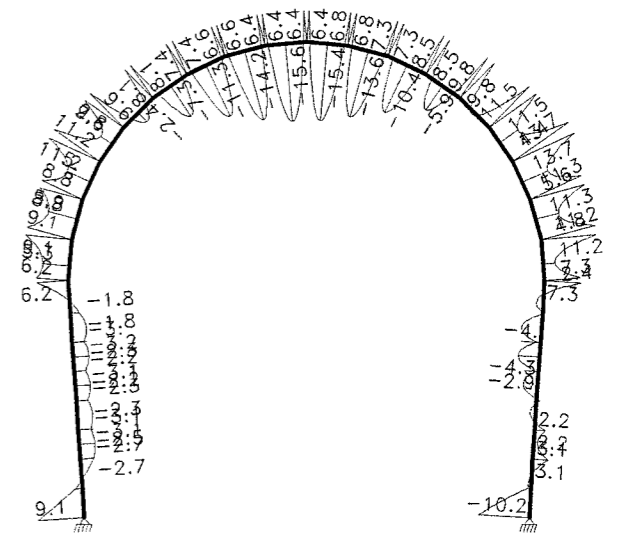
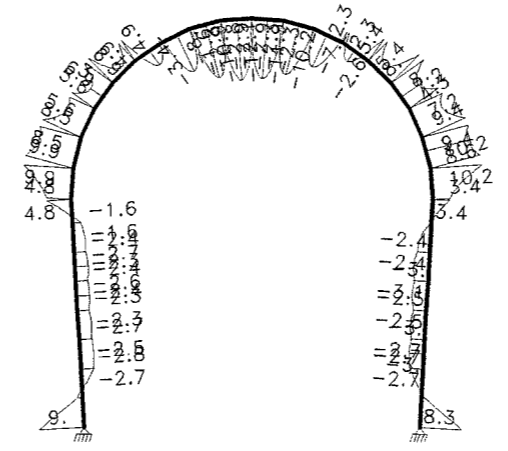
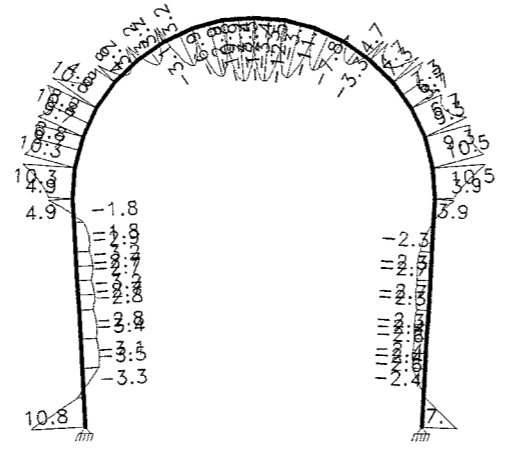
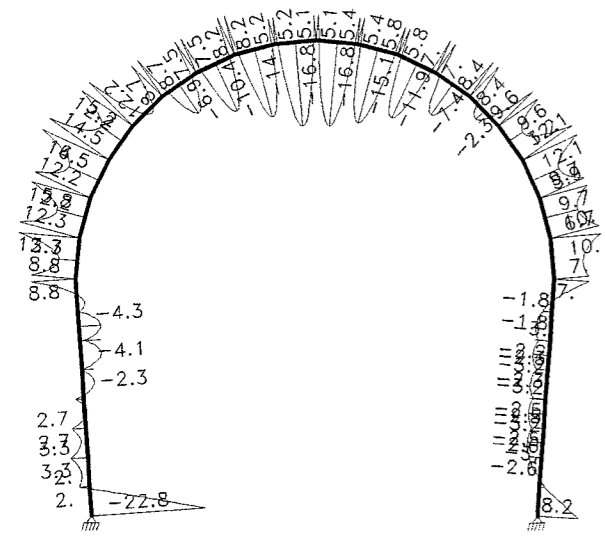

M3 MOMENT COMB. NO. 1 Combinao ELU1

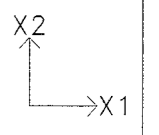

SCALE = 1:104

UNITS: kN

DATE:10-11-11

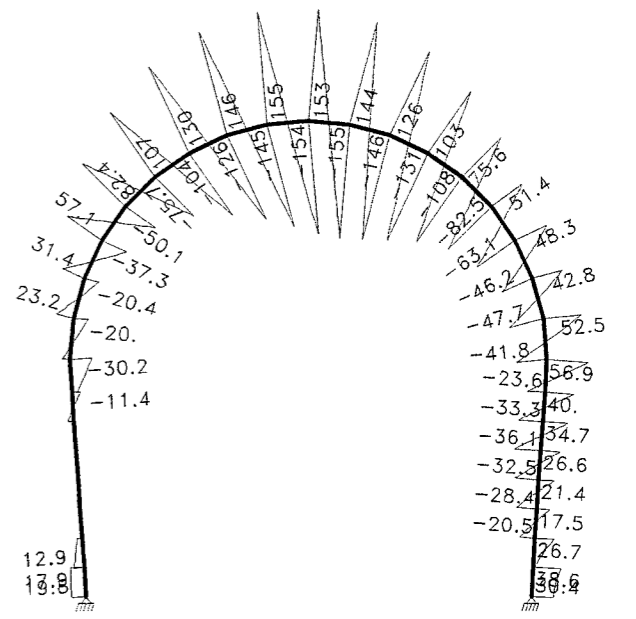
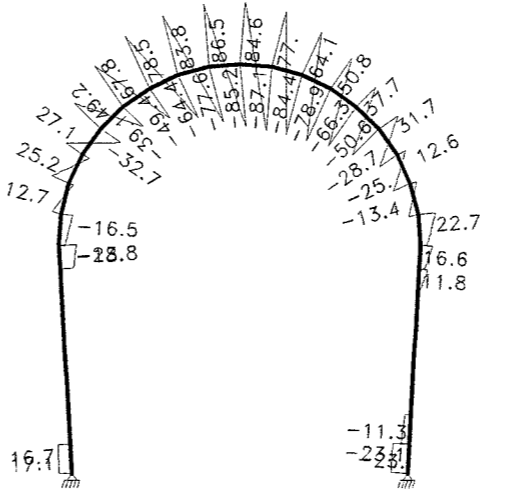
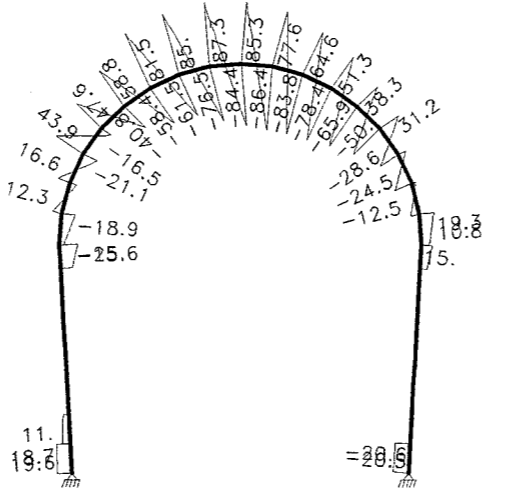
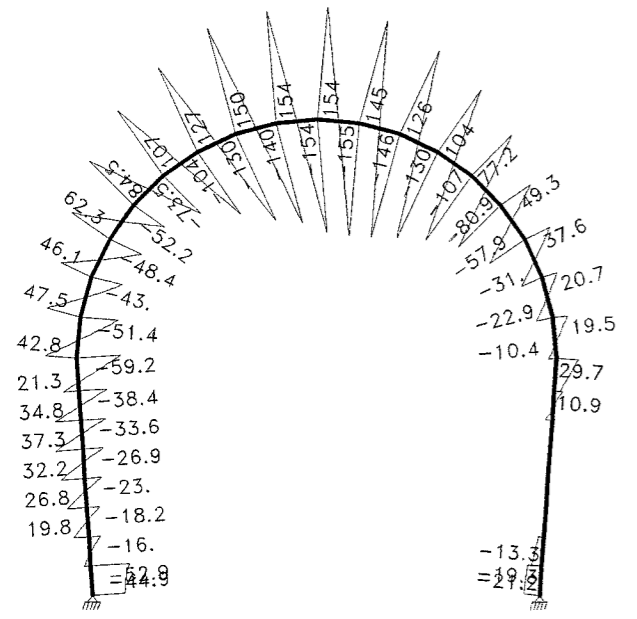

V2 SHEAR COMB. NO. 2 Combinac ELU2

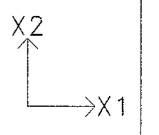

SCALE = 1:104

UNITS: kN*m

DATE:10-11-11

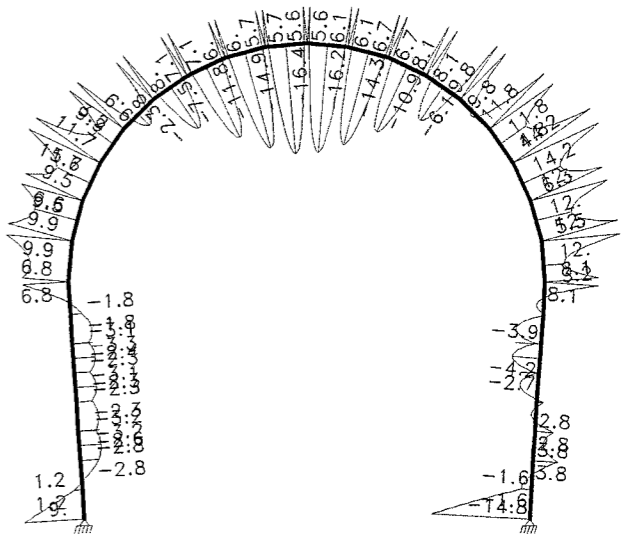
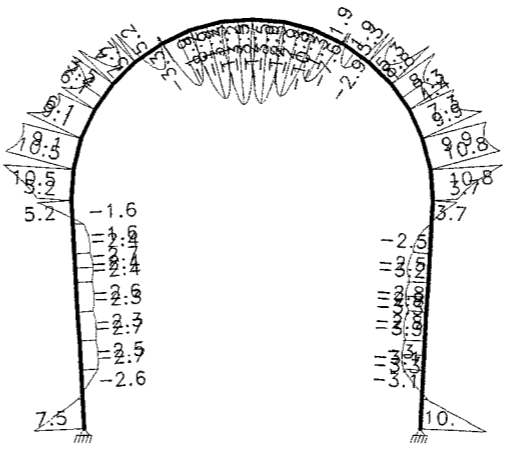
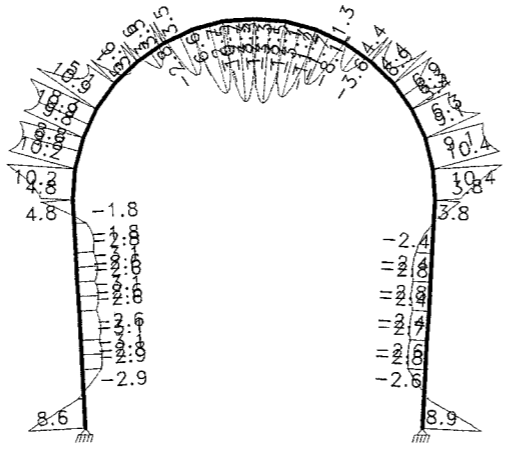
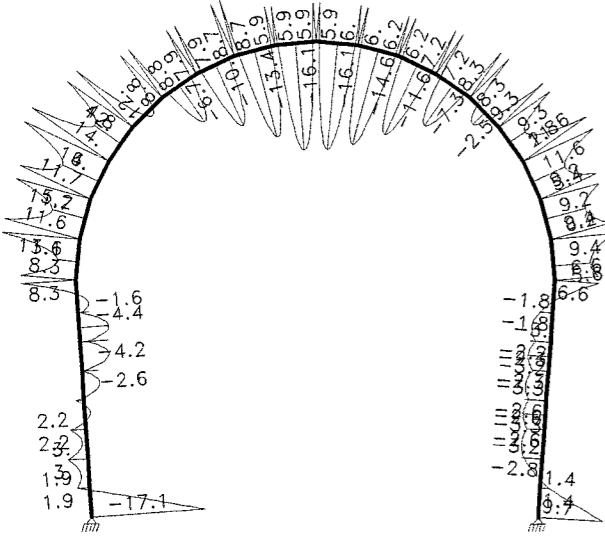

M3 MOMENT COMB. NO. 2 Combinao ELU2

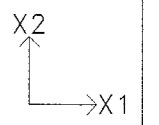

SCALE = 1:104

UNITS: kN

DATE:10-11-11

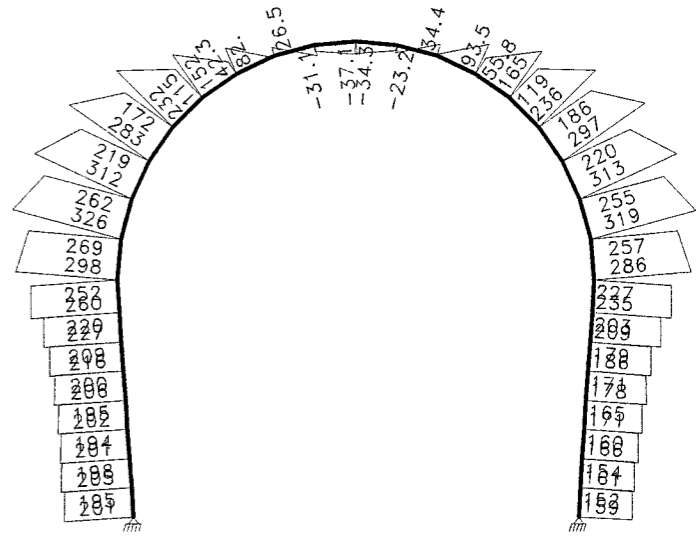
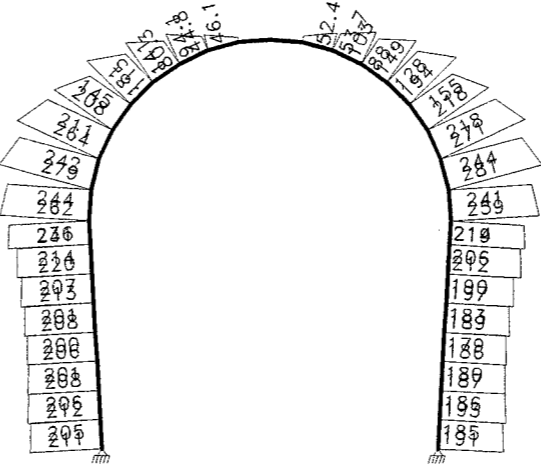
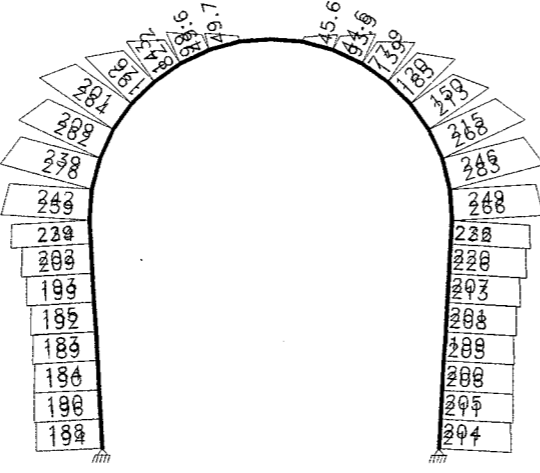
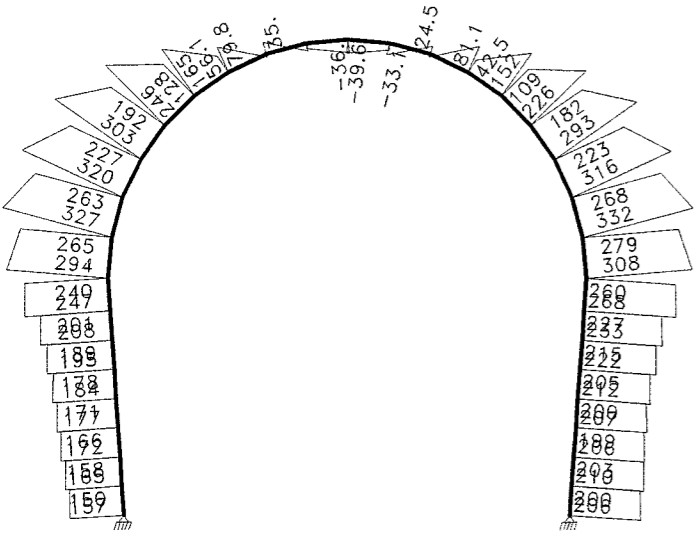

AXIAL FORCE COMB. NO. 3 Combinao FREQUENTE1



SCALE = 1:104

UNITS: kN

DATE:10-11-11

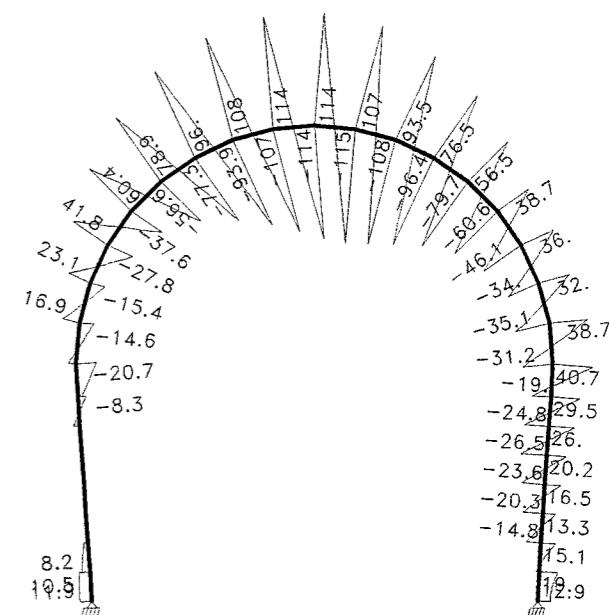
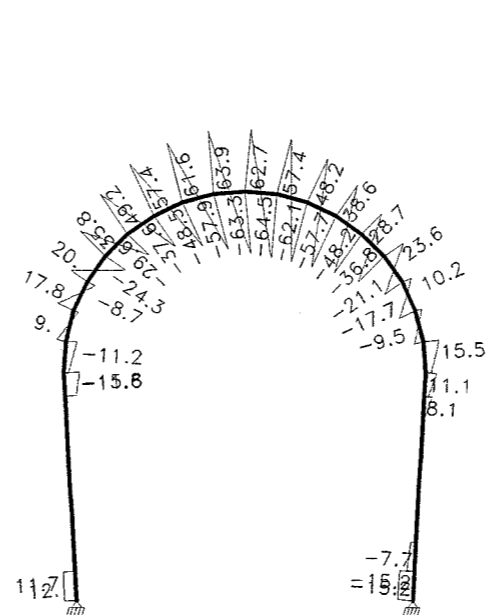
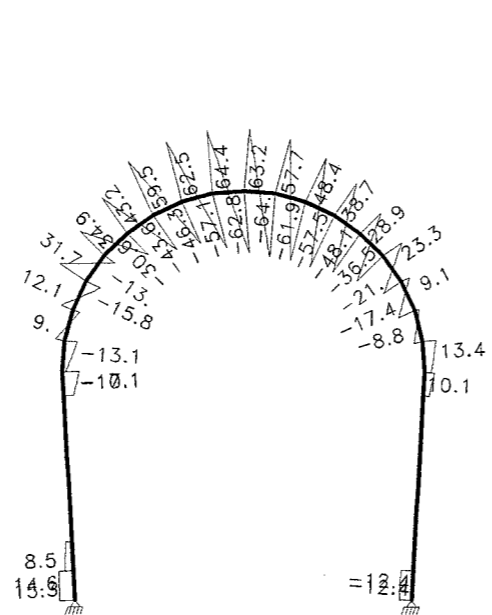
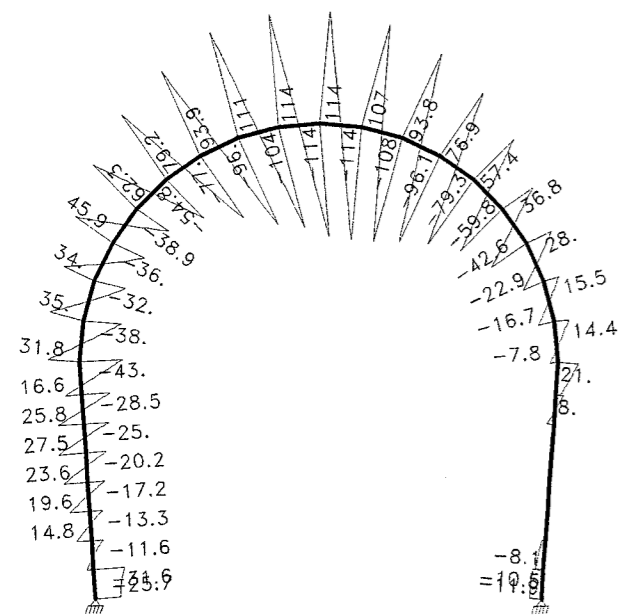

V2 SHEAR

COMB. NO. 3 Combinco FREQUENTE1

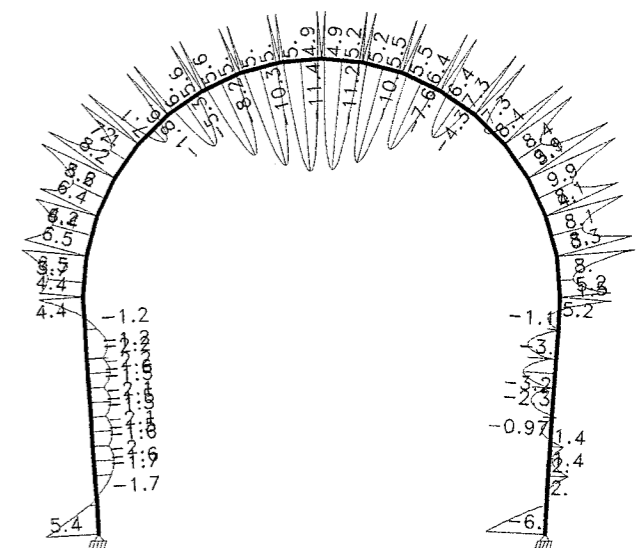
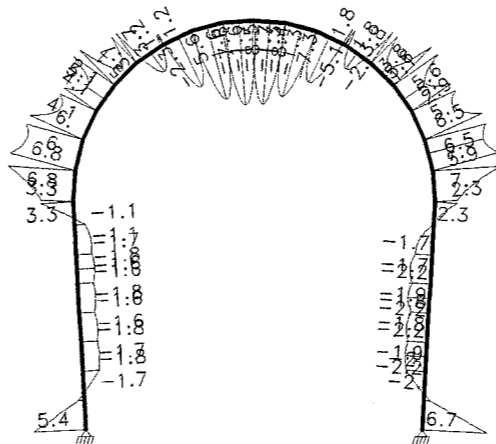
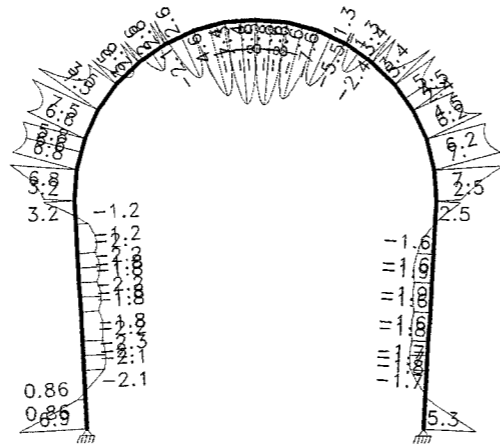
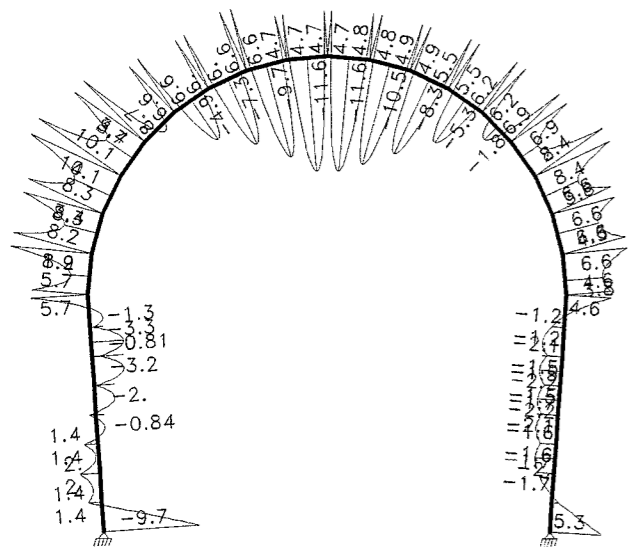
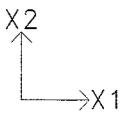

M3 MOMENT

COMB. NO. 3 Combinao FREQUENTE1

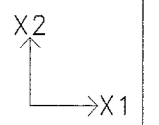

SCALE = 1:104

UNITS: kN

DATE:10-11-11

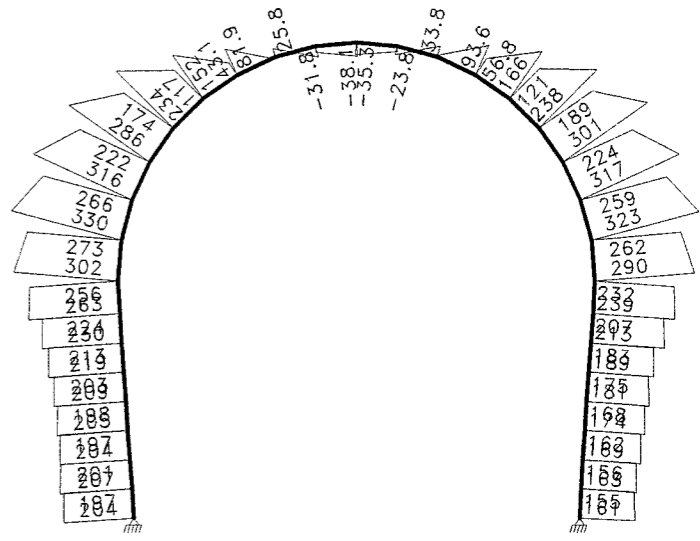
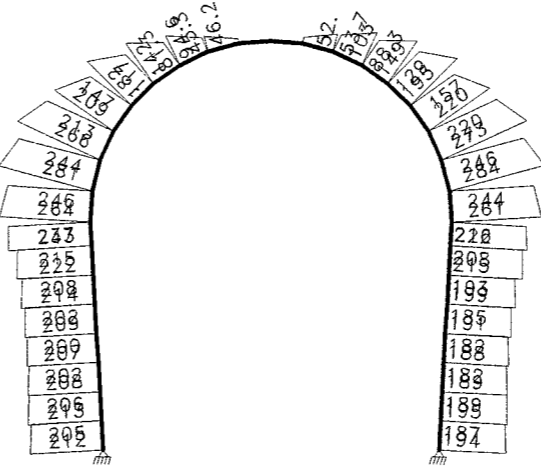
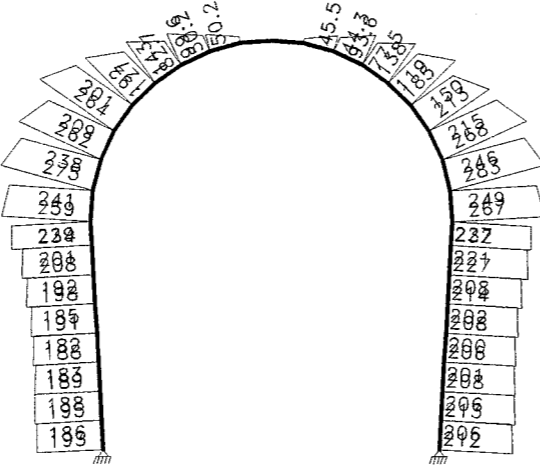
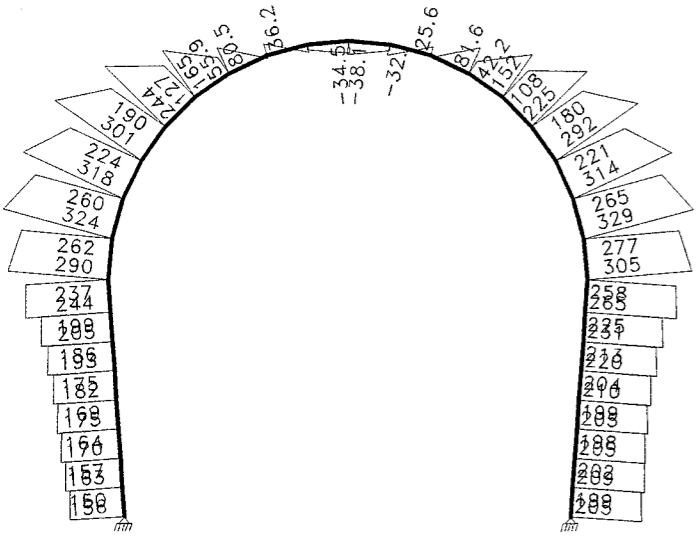

AXIAL FORCE COMB. NO. 4 Combinao FREQUENTE2

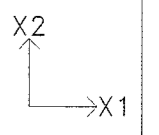

SCALE = 1:104

UNITS: kN

DATE:10-11-11

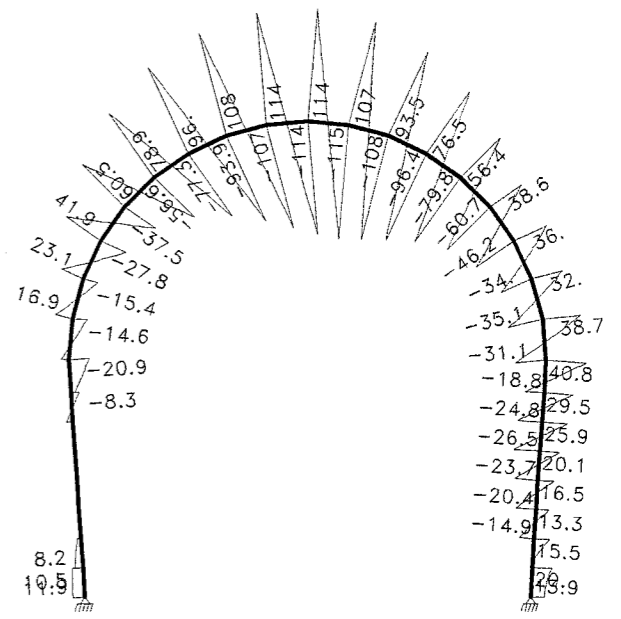
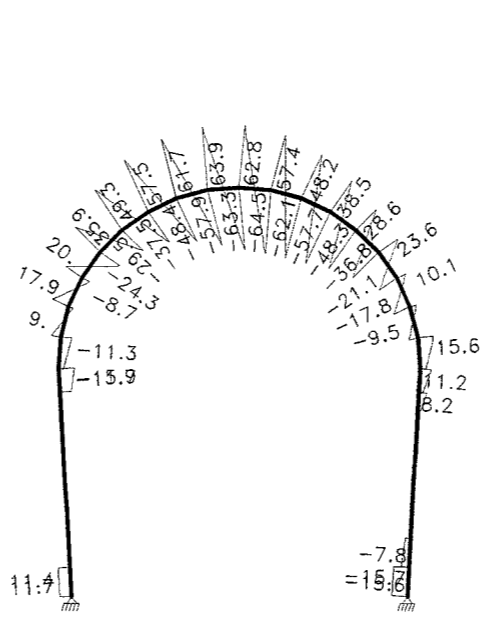
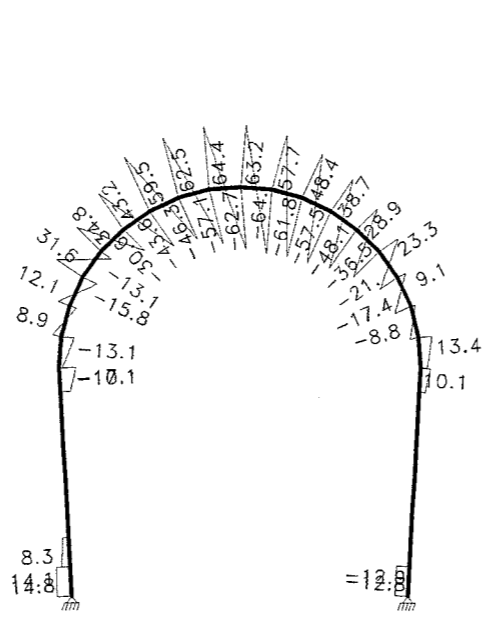
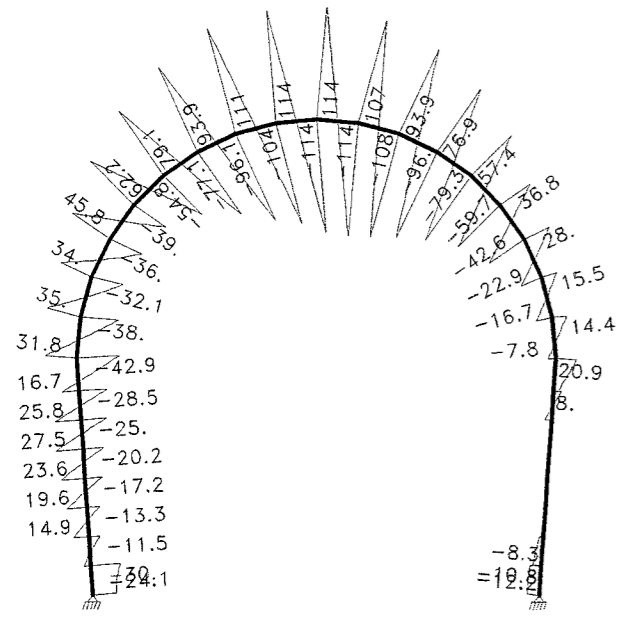

V2 SHEAR COMB. NO. 4 Combinco FREQUENTE2

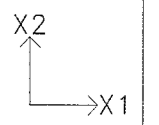

SCALE = 1:104

UNITS: kN*m

DATE:10-11-11

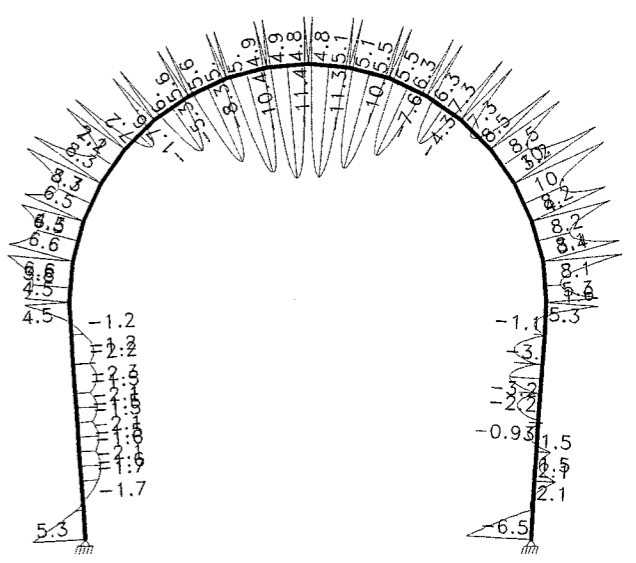
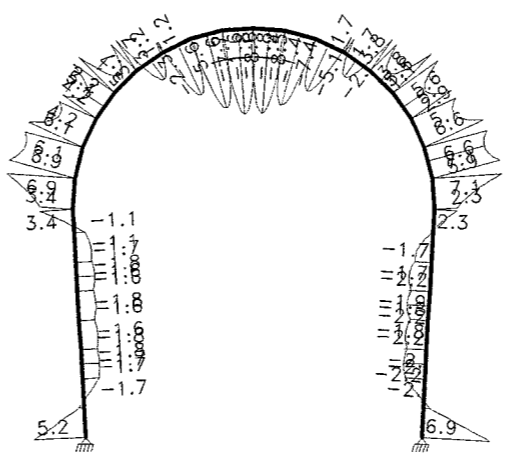
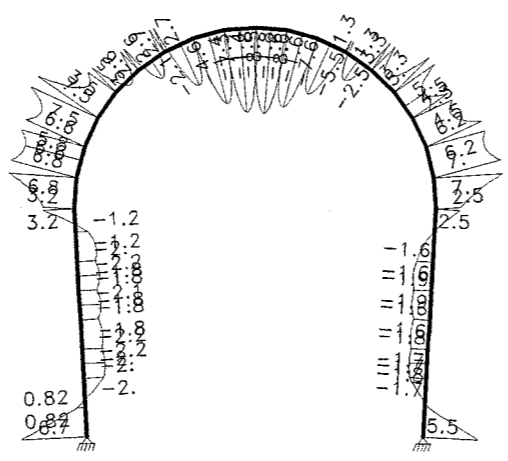
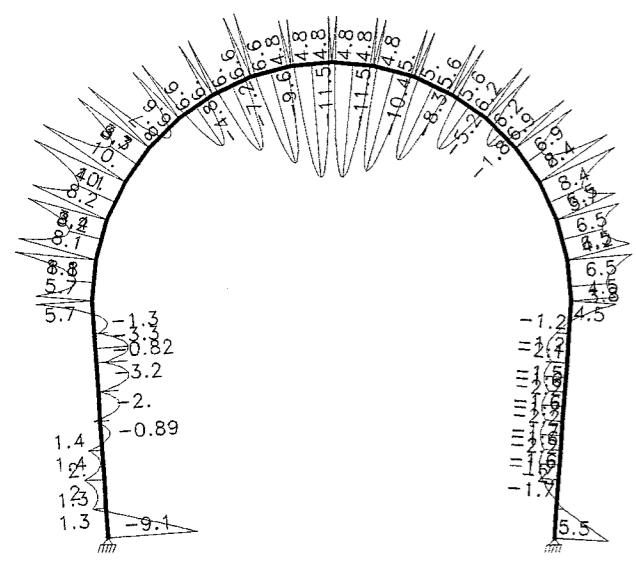

M3 MOMENT COMB. NO. 4 Combinao FREQUENTE2

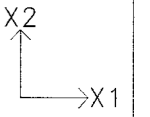

SCALE = 1:104

UNITS: kN

DATE:10-11-11

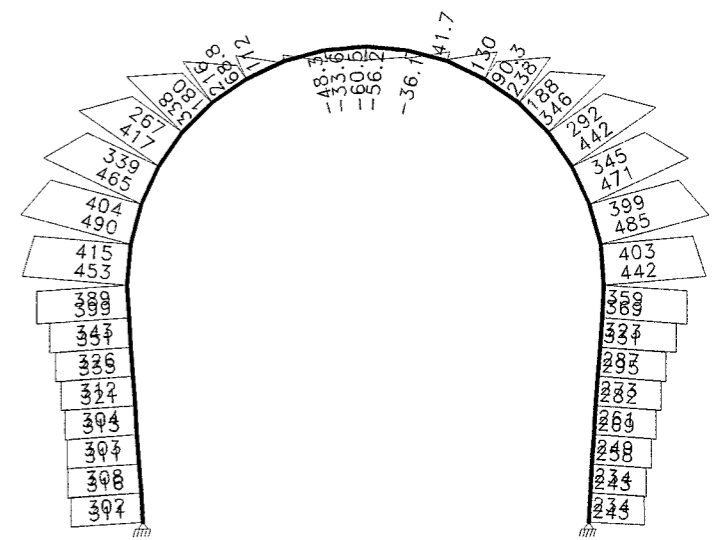
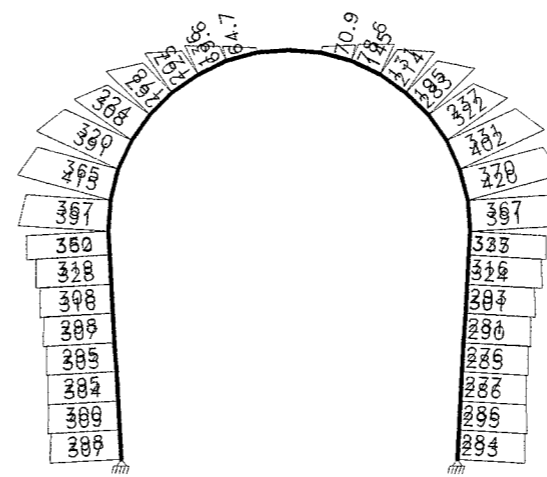
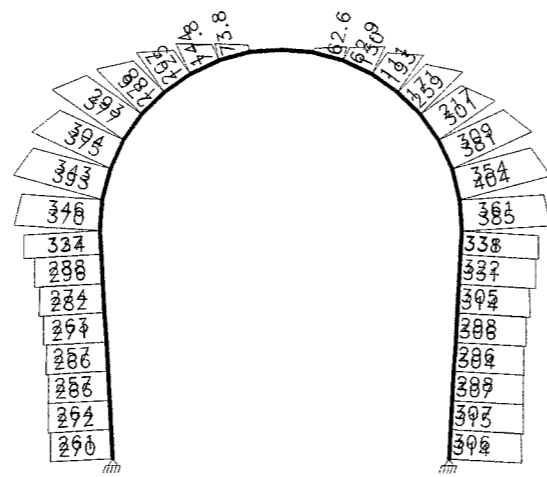
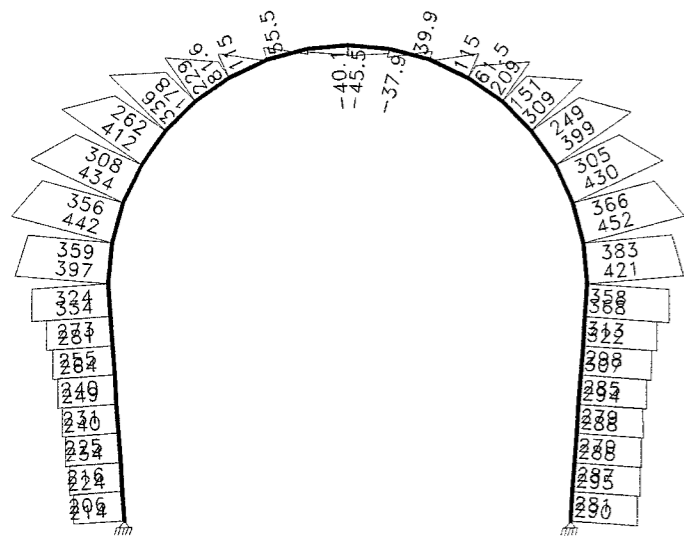

AXIAL FORCE COMB. NO. 5 Combinao ELU1 sem sobrecarga Hotel

Tnel_0+699m

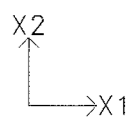

SCALE = 1:104

UNITS: kN

DATE:10-11-11

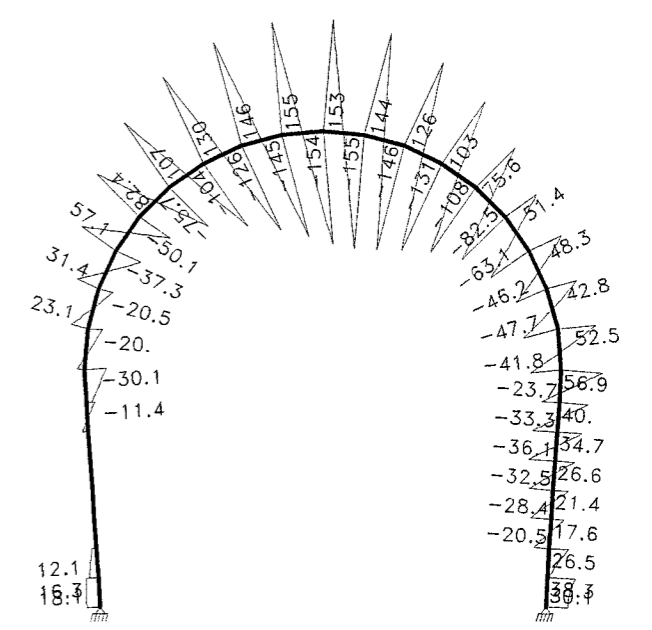
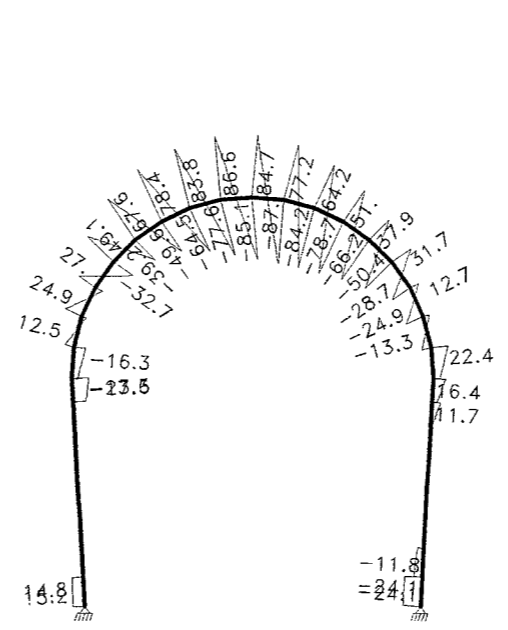
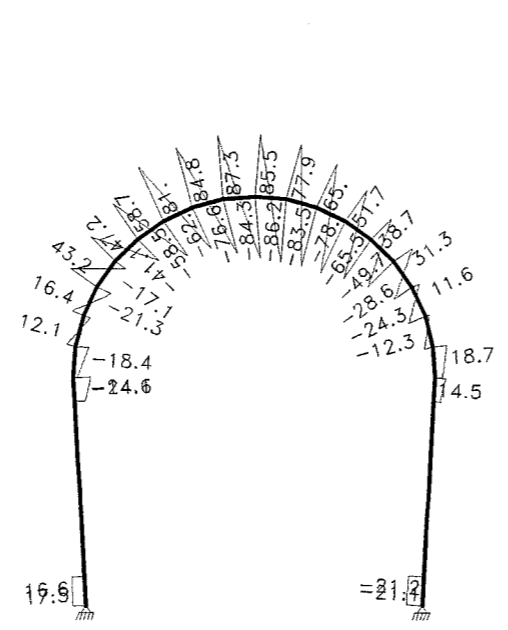
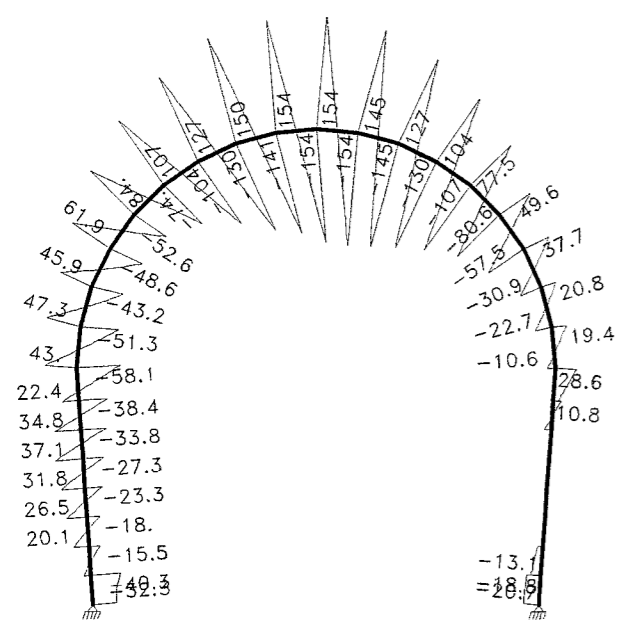

V2 SHEAR COMB. NO. 5 Combinco ELU1 sem sobrecarga Hotel

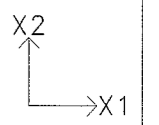

SCALE = 1:104

UNITS: kN*m

DATE:10-11-11

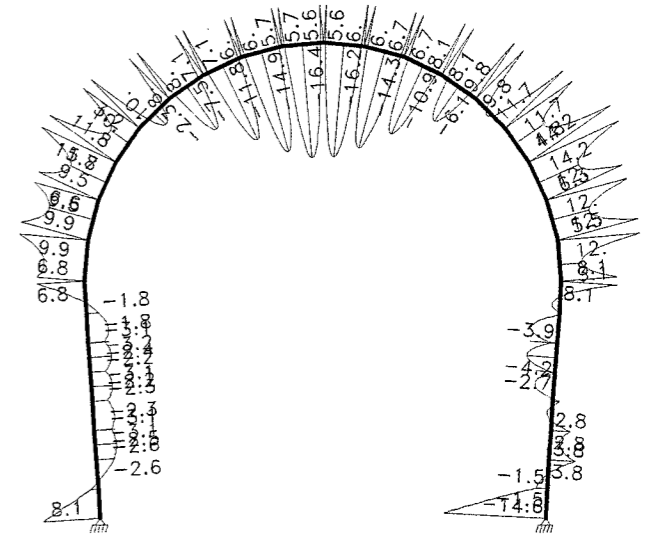
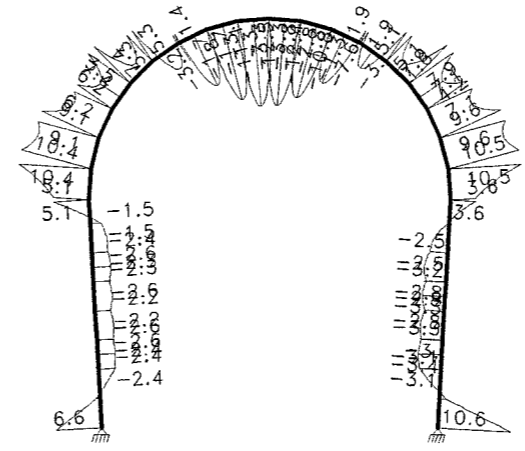
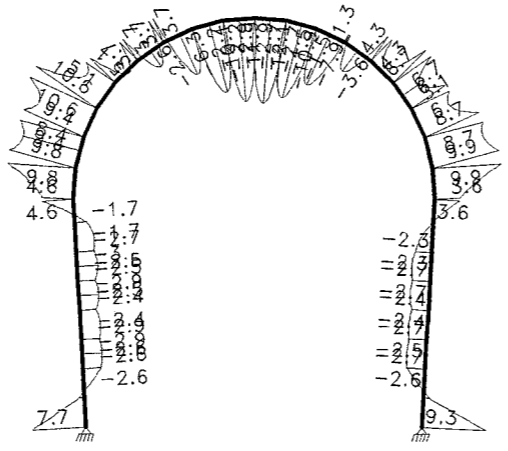
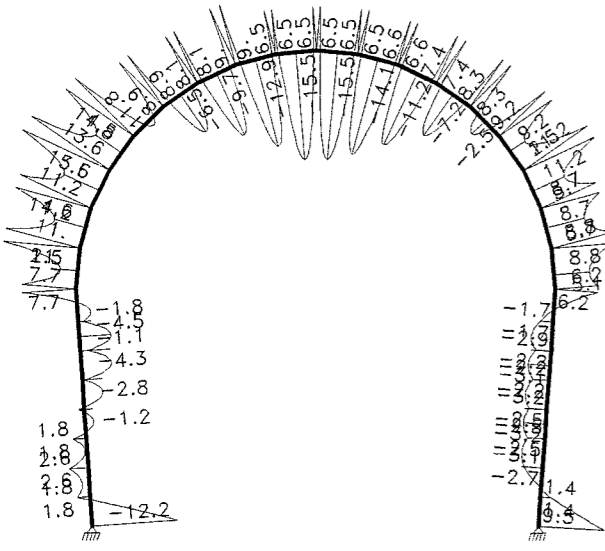

M3 MOMENT COMB. NO. 5 Combinao ELU1 sem sobrecarga Hotel

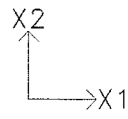

SCALE = 1:104

UNITS: kN

DATE:10-11-11

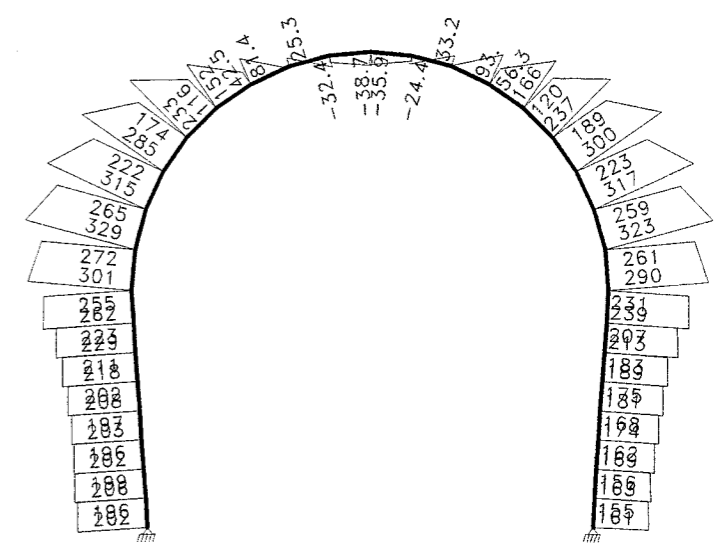
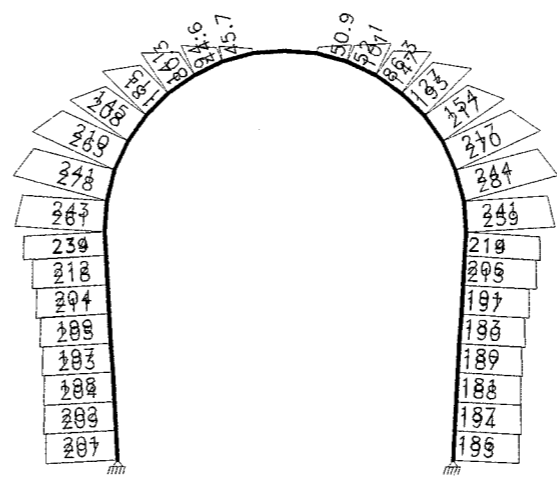
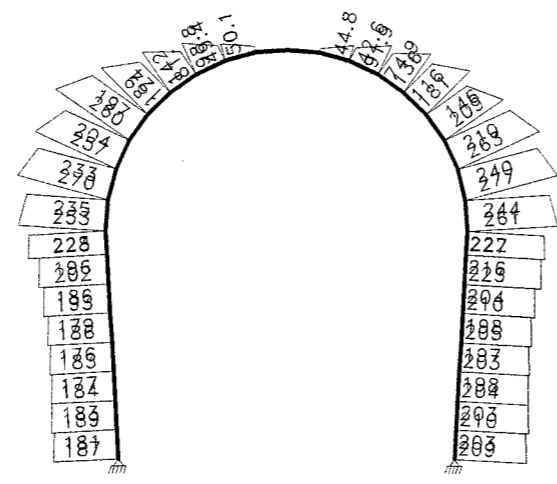
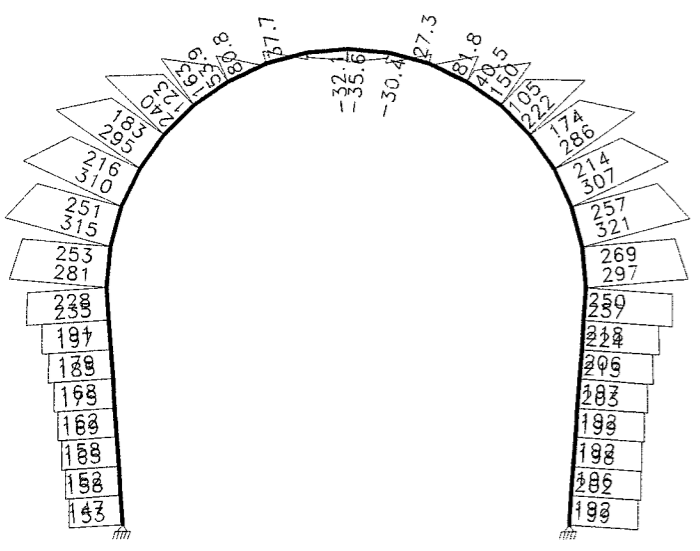

AXIAL FORCE COMB. NO. 6 Combinao FREQUENTE sem sobrecarga Hote

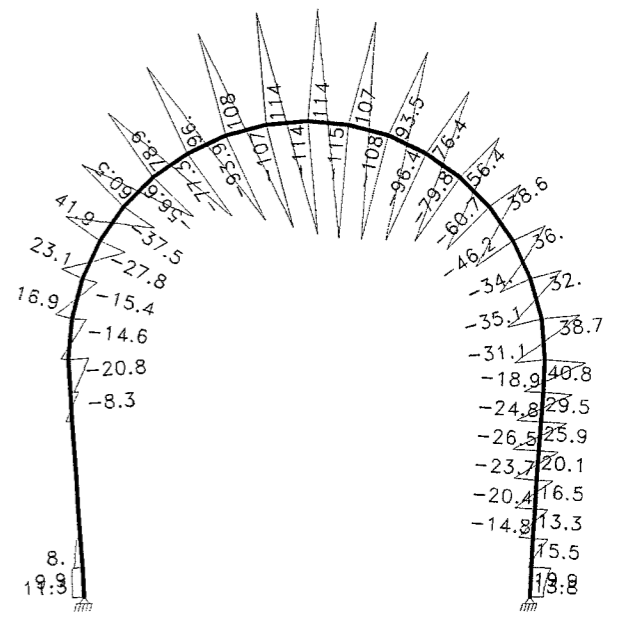
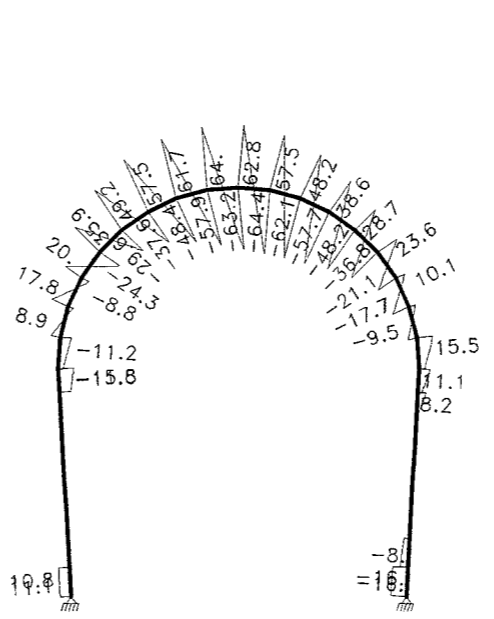
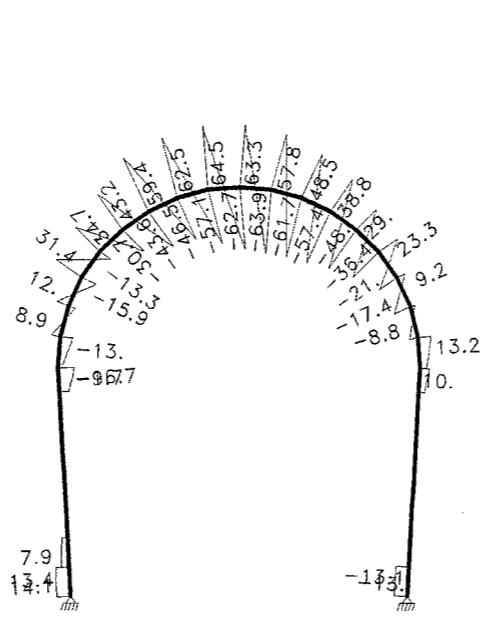
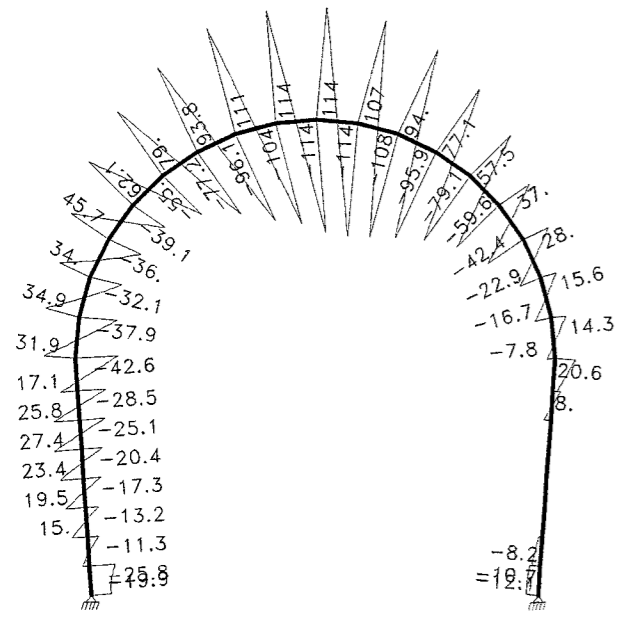
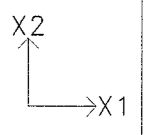

V2 SHEAR COMB. NO. 6 Combinacão FREQUENTE sem sobrecarga Hote

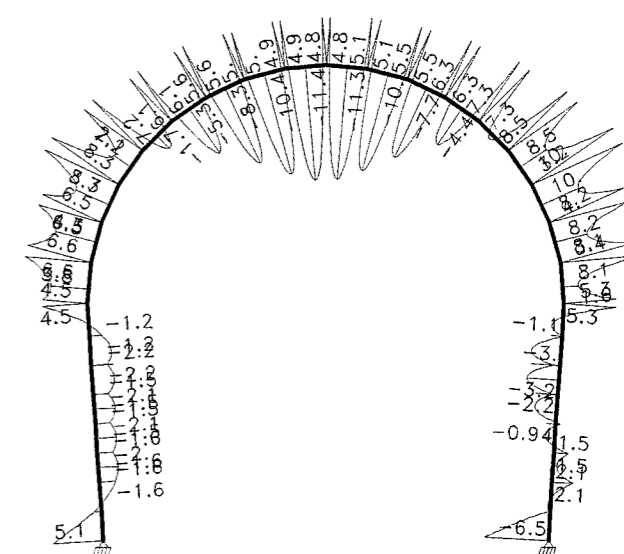
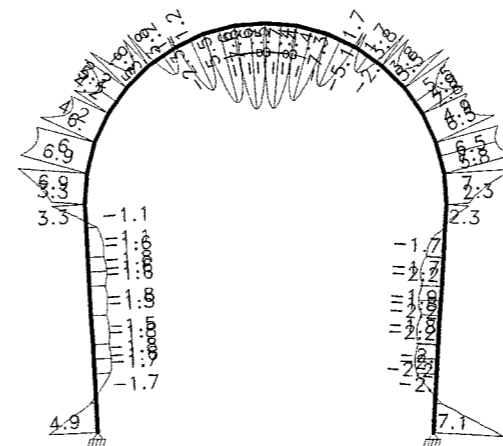
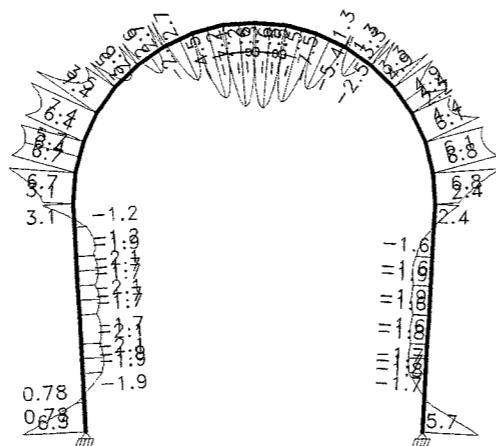
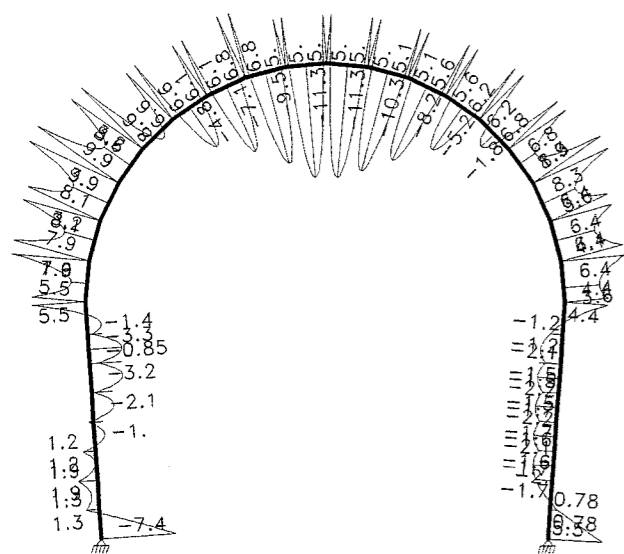
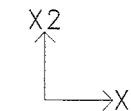

M3 MOMENT COMB. NO. 6 Combinao FREQUENTE sem sobrecarga Hote

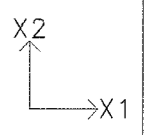

SCALE = 1:104

UNITS: meter

DATE:10-11-11

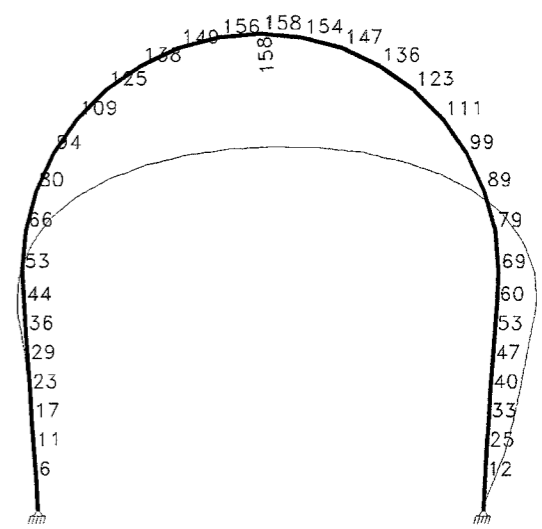
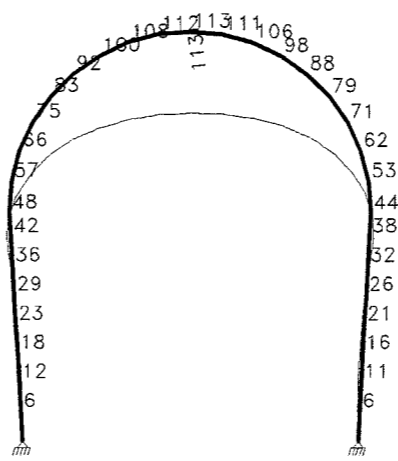
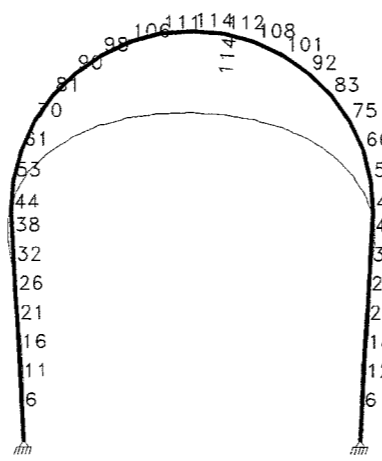
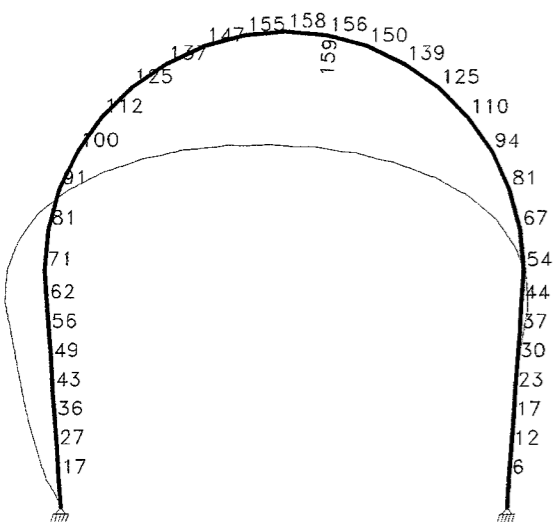

VALUES ARE * 10⁻⁶ DISPLACEMENTS LOAD NO. 2 P.P. Gran

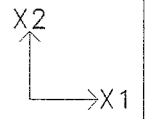

SCALE = 1:104

UNITS: meter

DATE:10-11-11

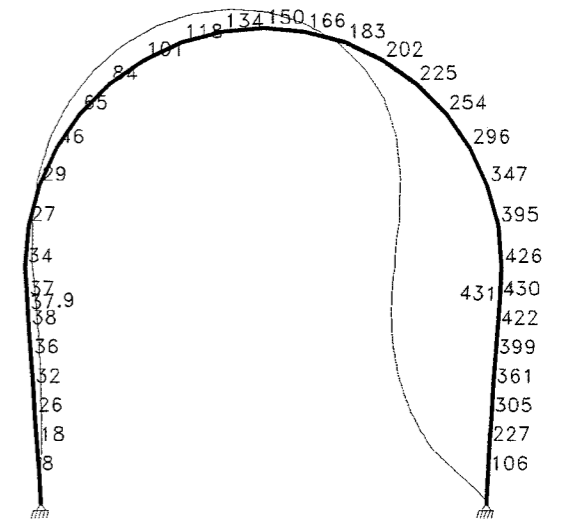
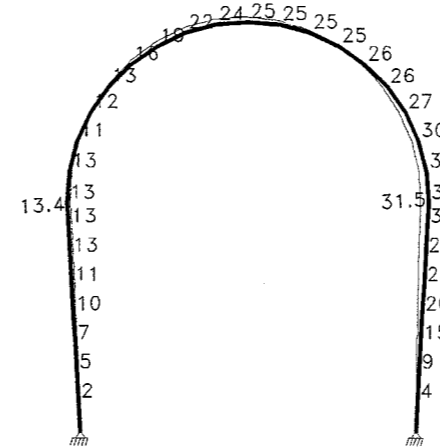
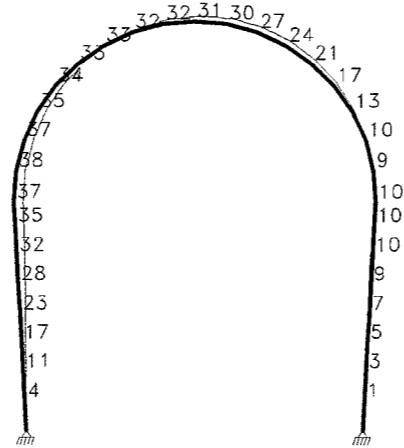
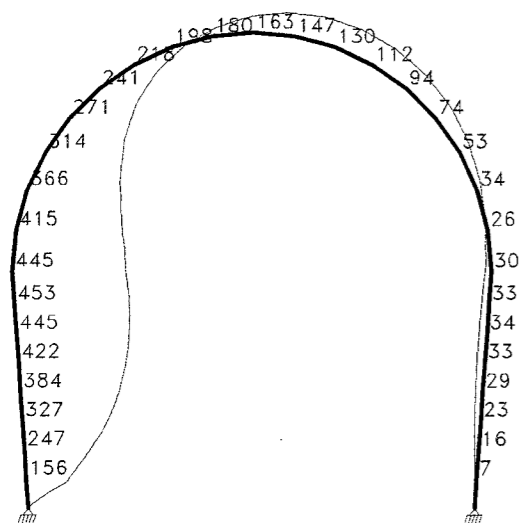

VALUES ARE * 10^-7
DISPLACEMENTS LOAD NO. 5 Carga_Horizontal

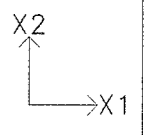

SCALE = 1:104

UNITS: kN

DATE:10-11-11

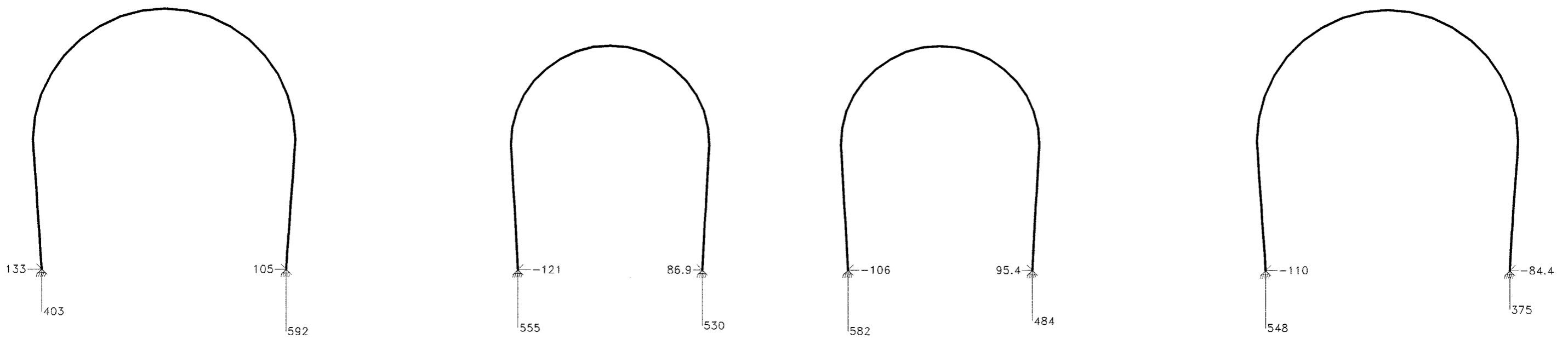

REACTIONS COMB. NO. 1 Combinac ELU1

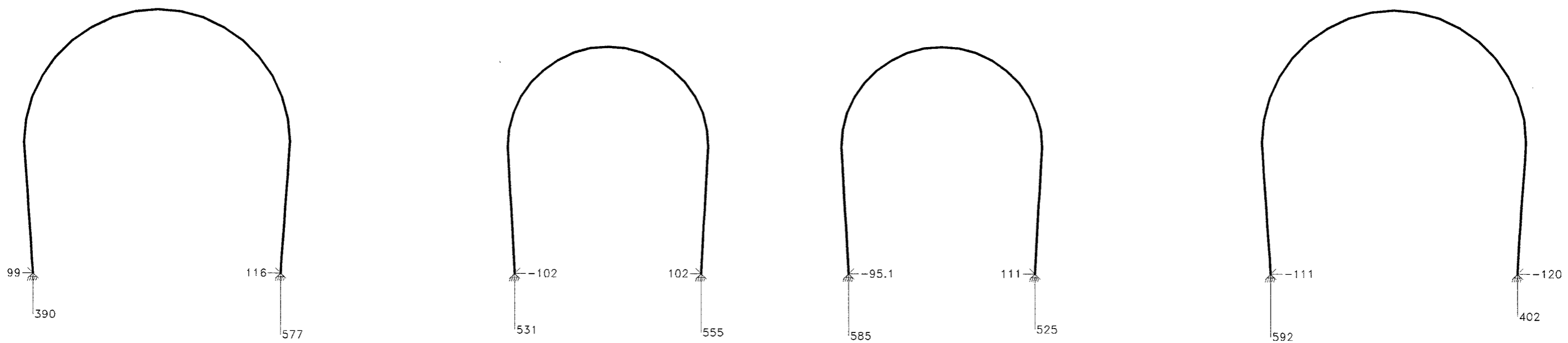
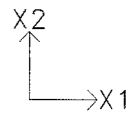

REACTIONS COMB. NO. 2 Combinac ELU2

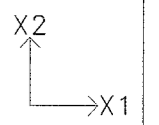

SCALE = 1:104

UNITS: kN

DATE:10-11-11



REACTIONS COMB. NO. 3 Combinac FREQUENTE1

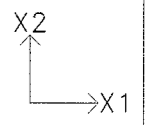

SCALE = 1:104

UNITS: kN

DATE:10-11-11

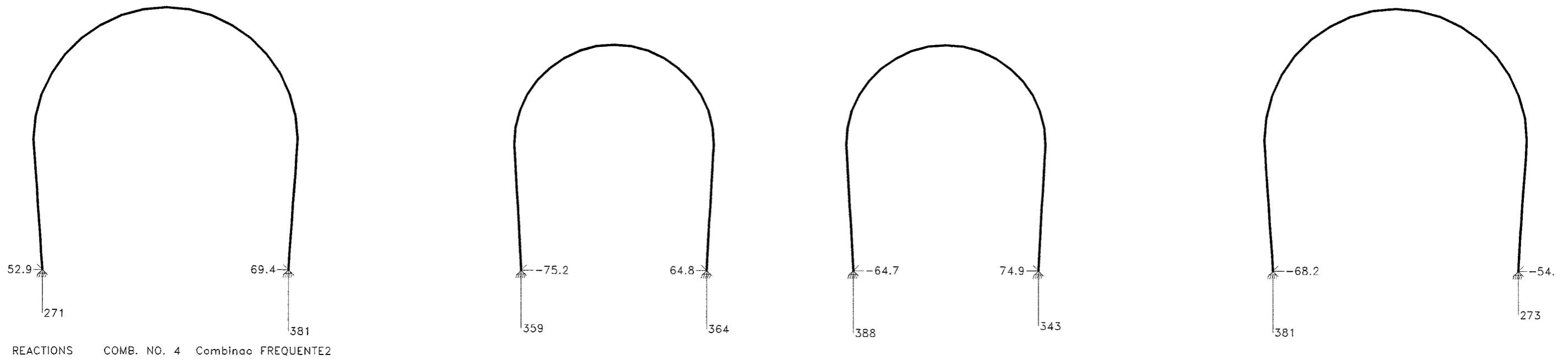

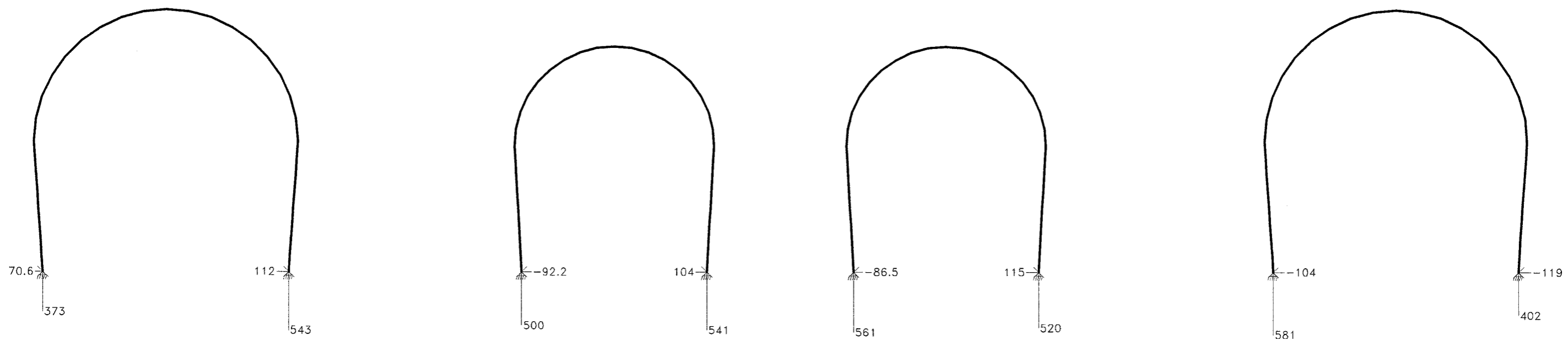
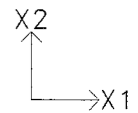

REACTIONS COMB. NO. 5 Combinac ELU1 sem sobrecarga Hotel

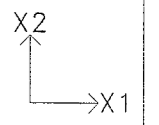

SCALE = 1:104

UNITS: kN

DATE:10-11-11

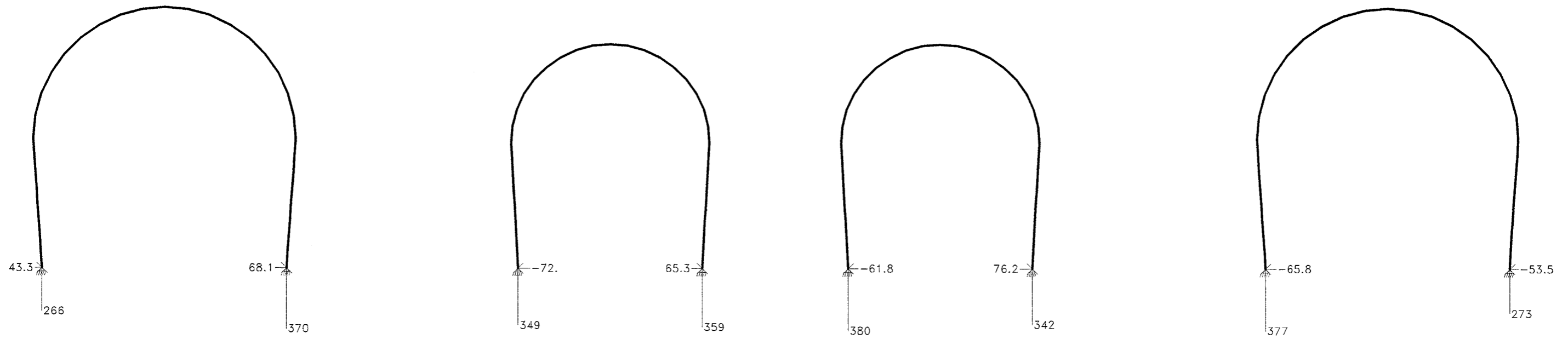

REACTIONS COMB. NO. 6 Combinao FREQUENTE sem sobrecarga Hote

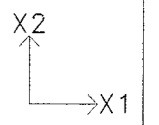

SCALE = 1:221

UNITS: kN m

DATE:10-11-11

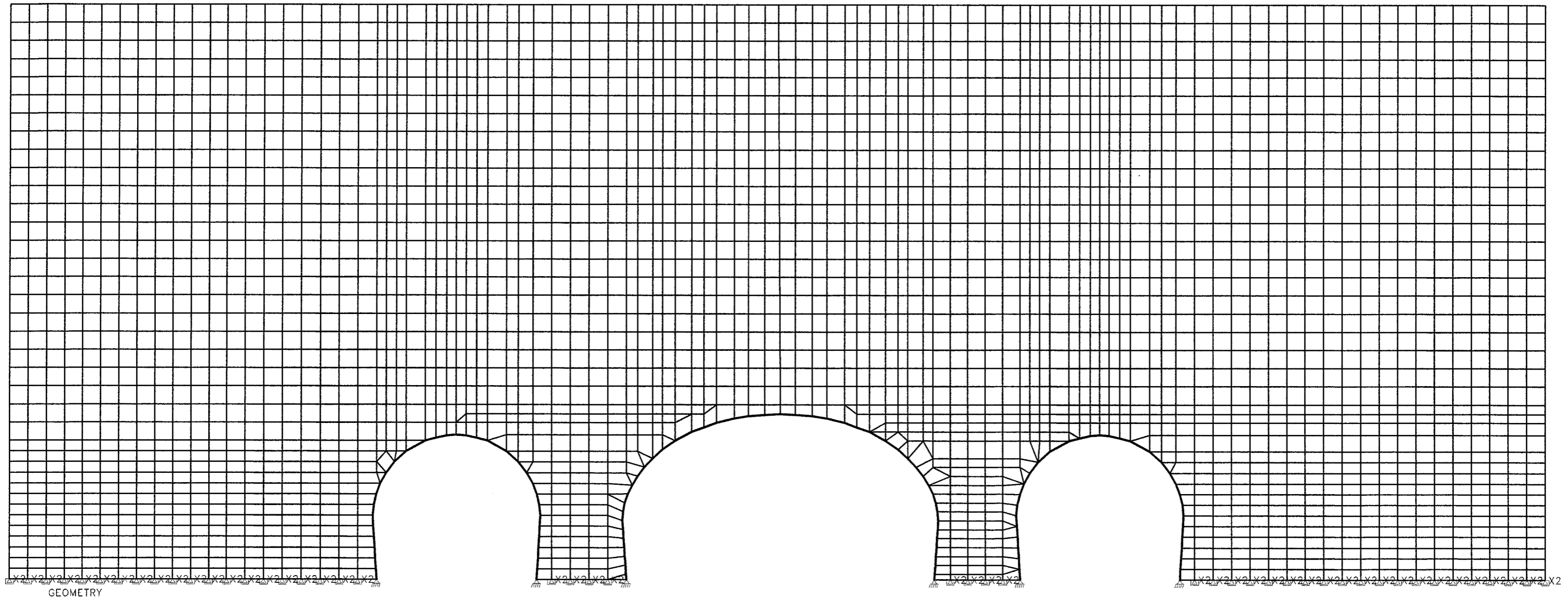

GEOMETRY

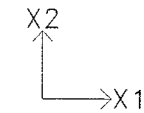

SCALE = 1:127

UNITS: kN

DATE:10-11-11



AXIAL FORCE COMB. NO. 1 Combinao ELU1

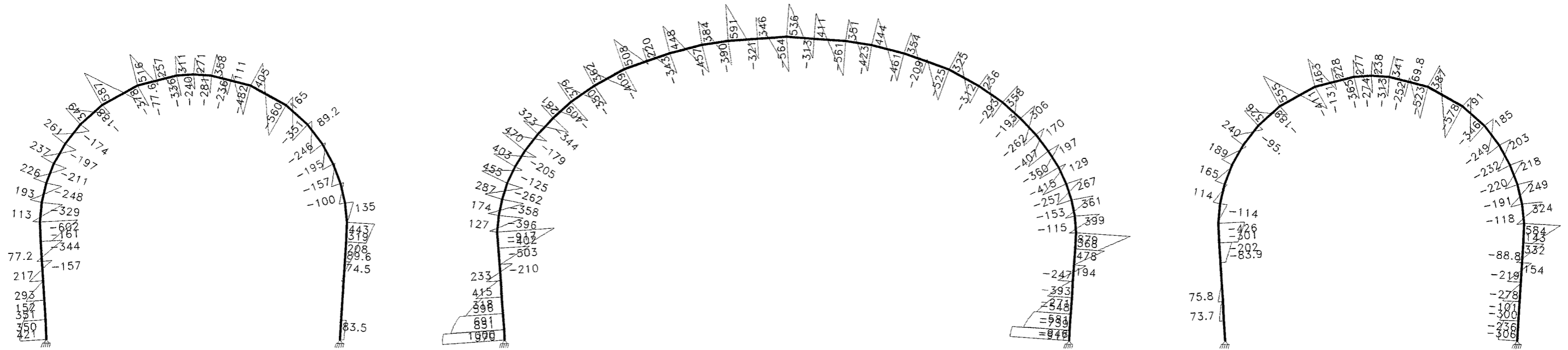

V2 SHEAR COMB. NO. 1 Combinao ELU1

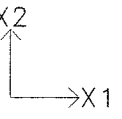

SCALE = 1:127

UNITS: kN*m

DATE:10-11-11

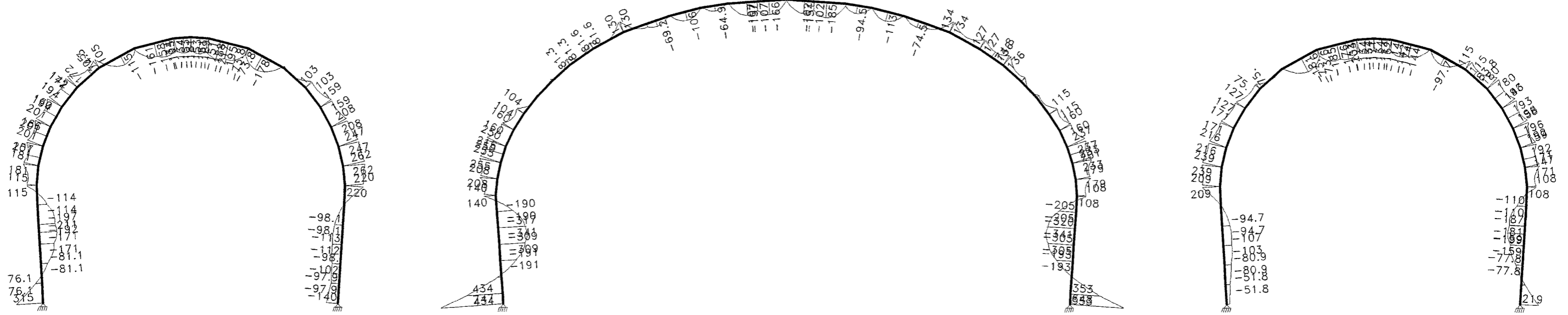

M3 MOMENT

COMB. NO. 1 Combinao ELU1

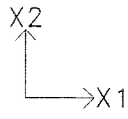

SCALE = 1:127

UNITS: kN

DATE:10-11-11

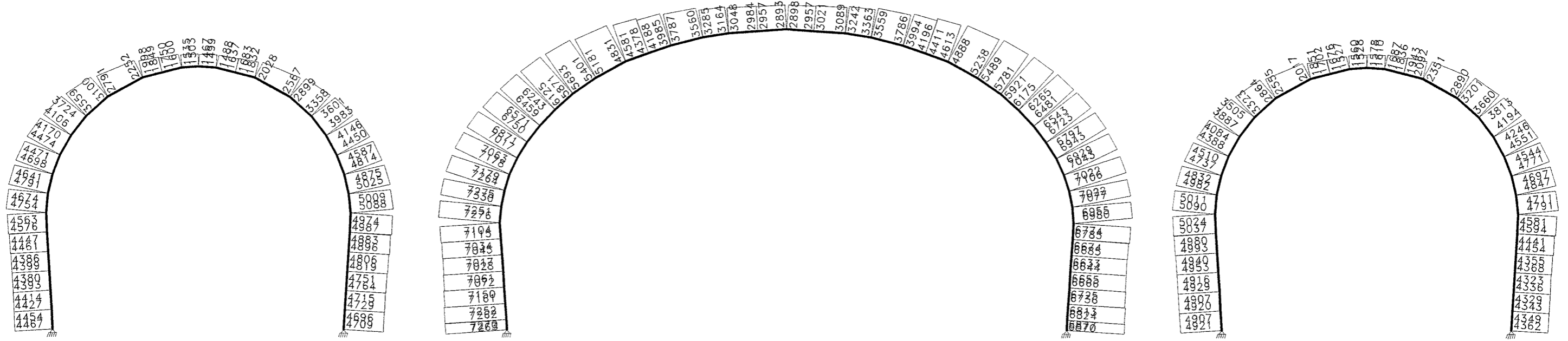

AXIAL FORCE COMB. NO. 2 Combinao ELU2

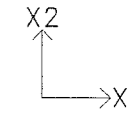

SCALE = 1:127

UNITS: kN

DATE:10-11-11

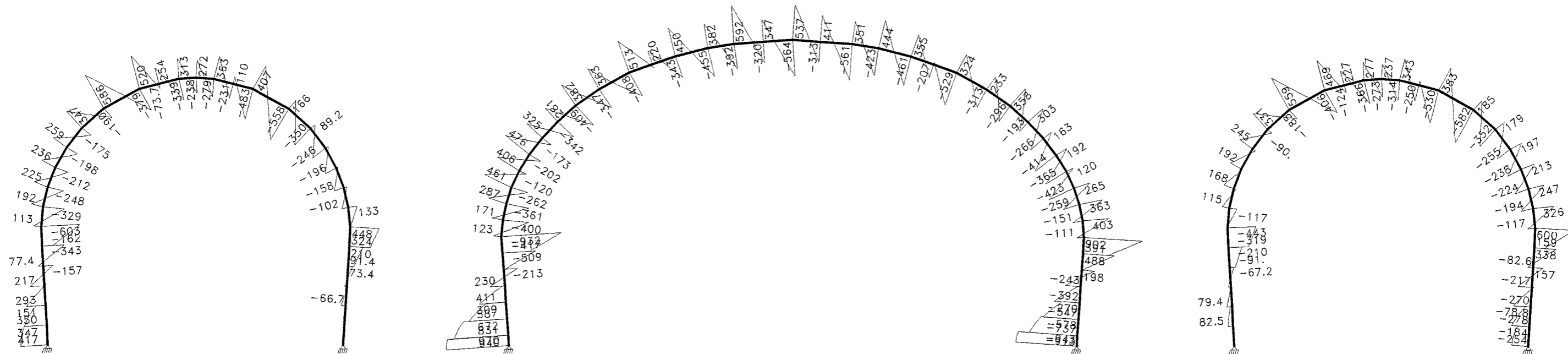

V2 SHEAR COMB. NO. 2 Combinao ELU2

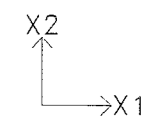

SCALE = 1:127

UNITS: kN*m

DATE:10-11-11

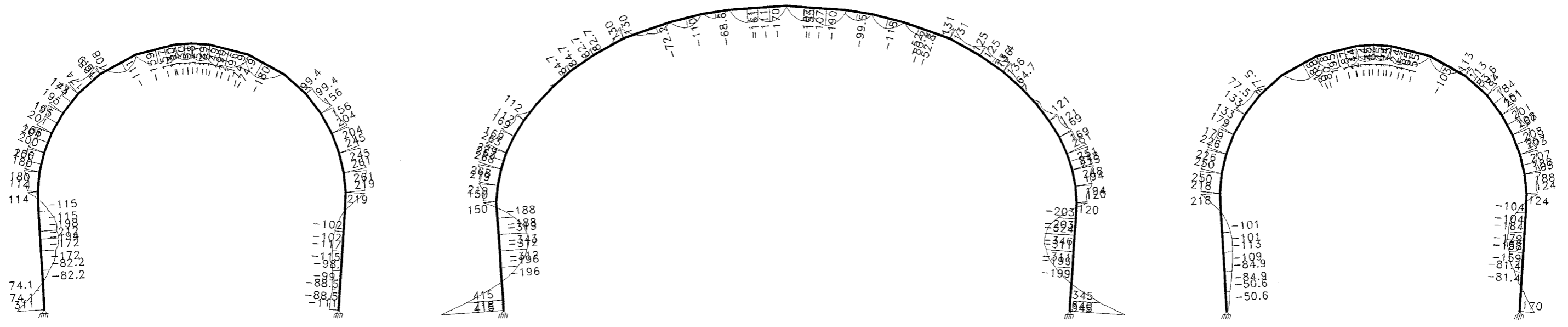

M3 MOMENT

COMB. NO. 2 Combinao ELU2

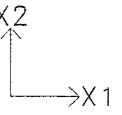

SCALE = 1:127

UNITS: kN

DATE:10-11-11

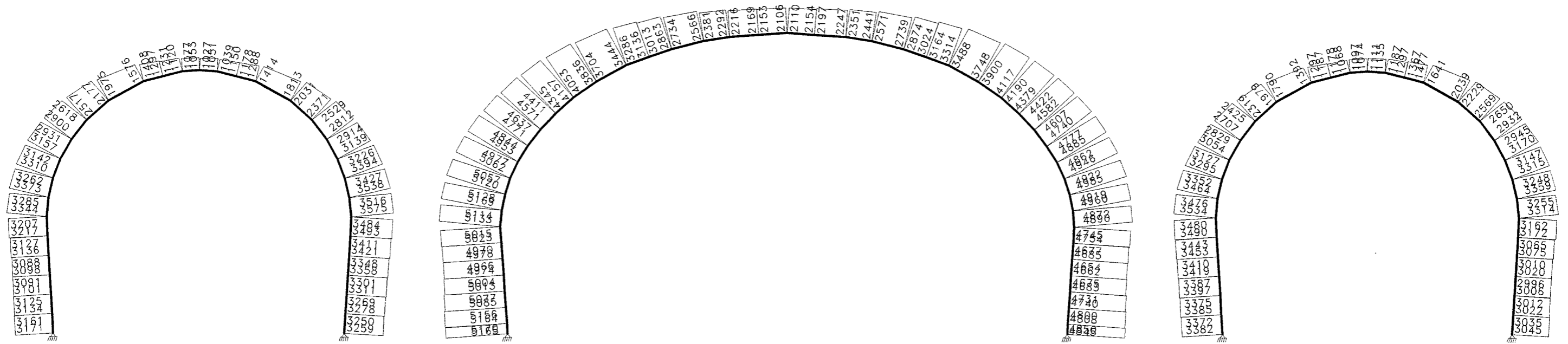

AXIAL FORCE

COMB. NO. 3 Combinao FREQUENTE1

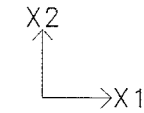

SCALE = 1:127

UNITS: kN

DATE:10-11-11

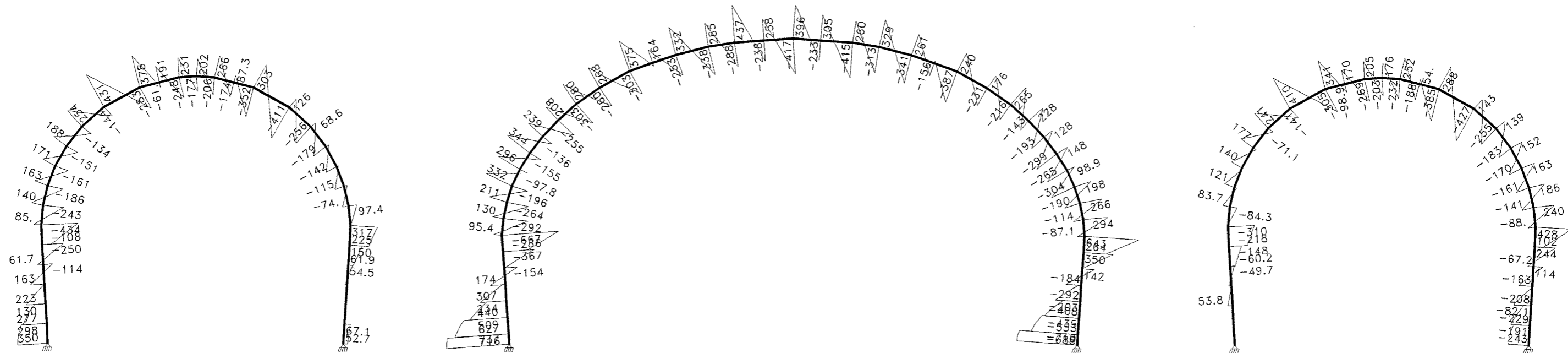

V2 SHEAR COMB. NO. 3 Combinao FREQUENTE1

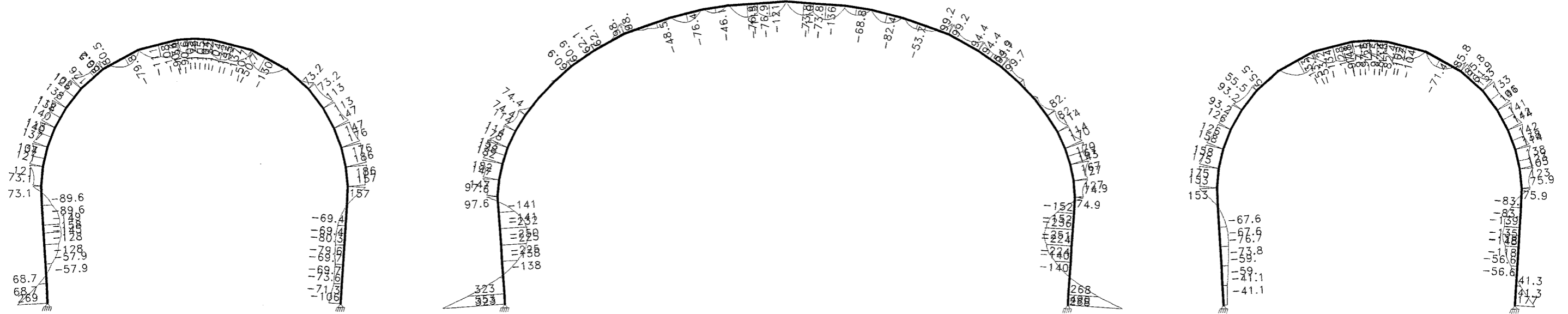

M3 MOMENT

COMB. NO. 3 Combinoo FREQUENTE1

SCALE = 1:127

UNITS: kN

DATE:10-11-11

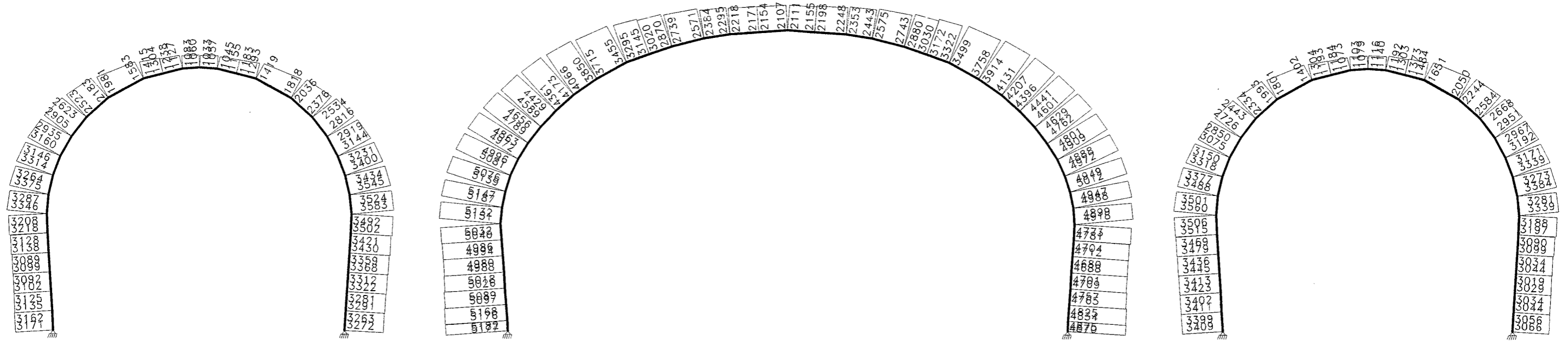

AXIAL FORCE

COMB. NO. 4 Combinao FREQUENTE2

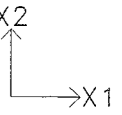

SCALE = 1:127

UNITS: kN

DATE:10-11-11

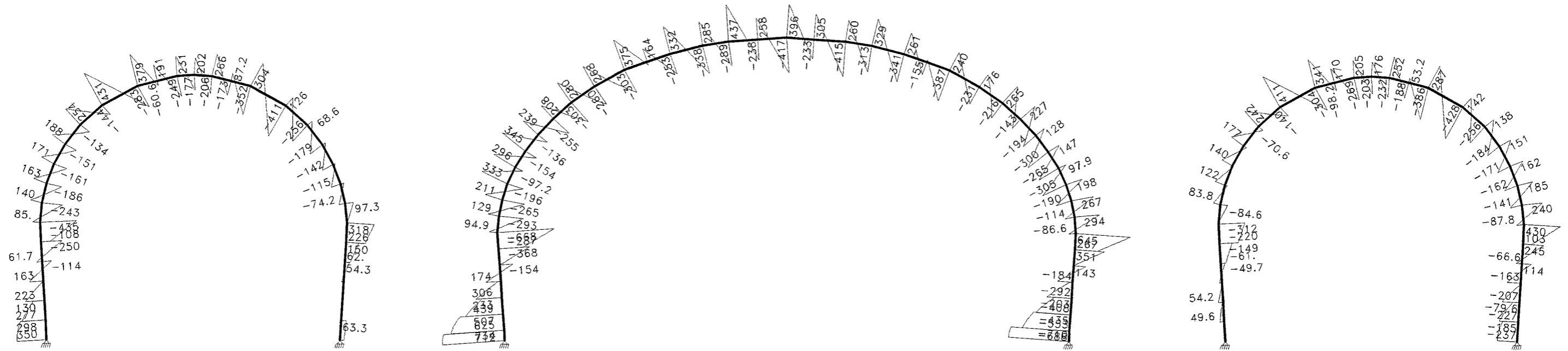

V2 SHEAR

COMB. NO. 4 Combinao FREQUENTE2

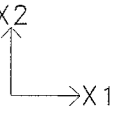

SCALE = 1:127

UNITS: kN*m

DATE:10-11-11

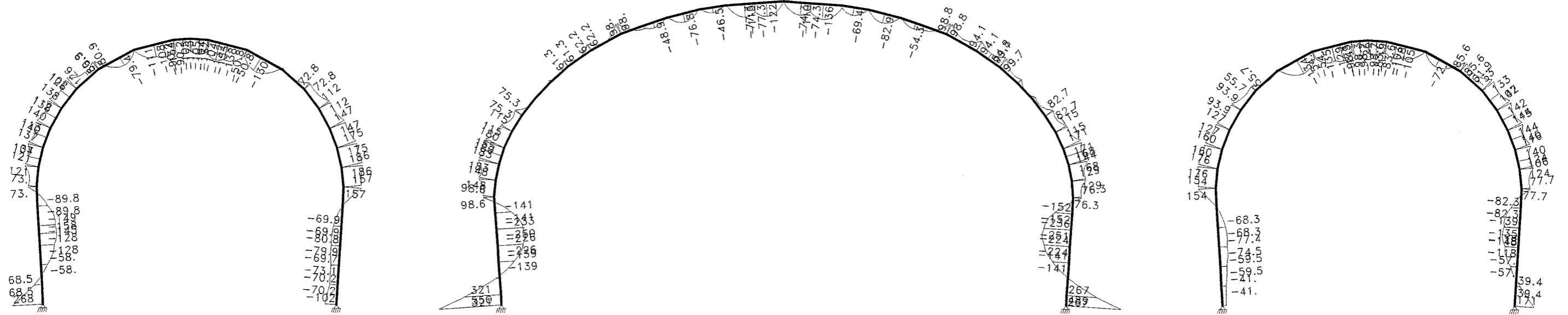

M3 MOMENT

COMB. NO. 4 Combinao FREQUENTE2

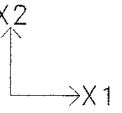

SCALE = 1:127

UNITS: kN*m

DATE:10-11-11

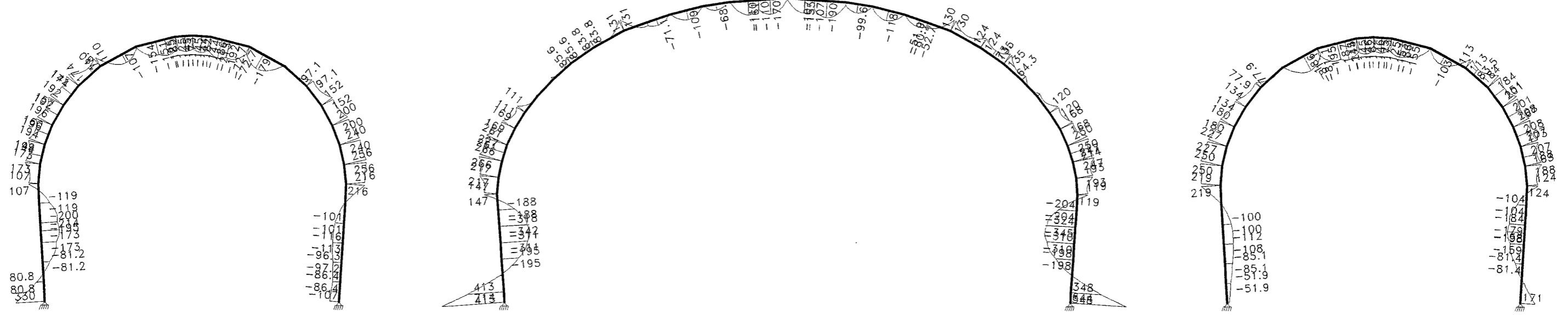

M3 MOMENT

COMB. NO. 5 Combinao ELU1 sem efeito hotel

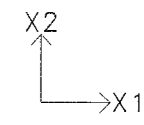

SCALE = 1:127

UNITS: kN

DATE:10-11-11

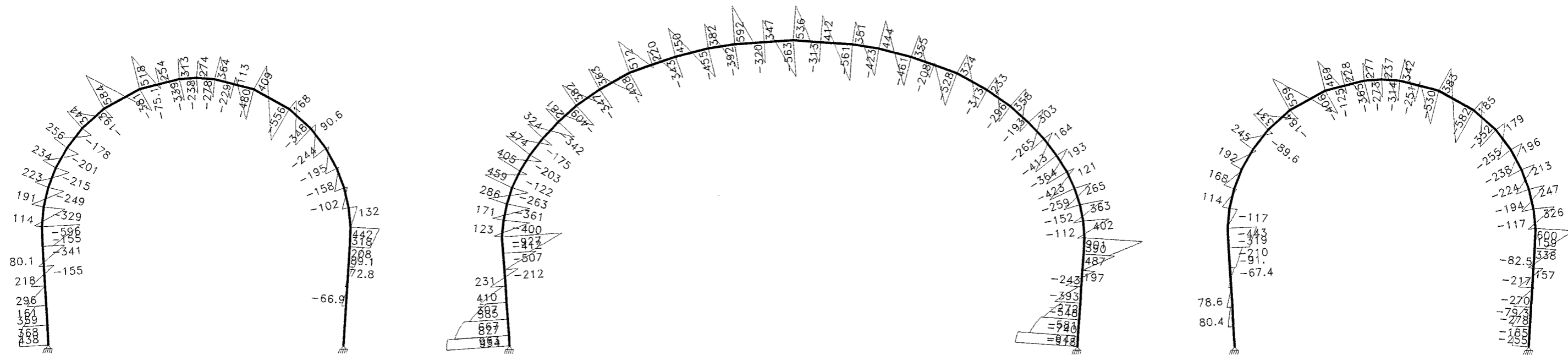

V2 SHEAR COMB. NO. 5 Combinao ELU1 sem efeito hotel

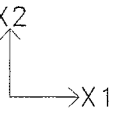

SCALE = 1:127

UNITS: kN

DATE:10-11-11

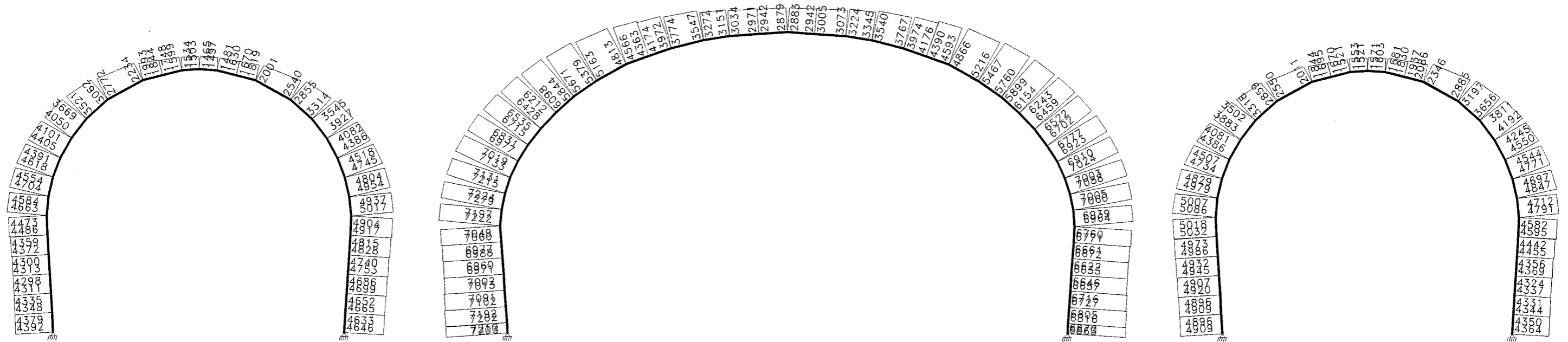

AXIAL FORCE COMB. NO. 5 Combinao ELU1 sem efeito hotel

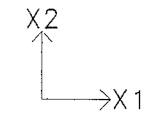

SCALE = 1:127

UNITS: kN

DATE:10-11-11

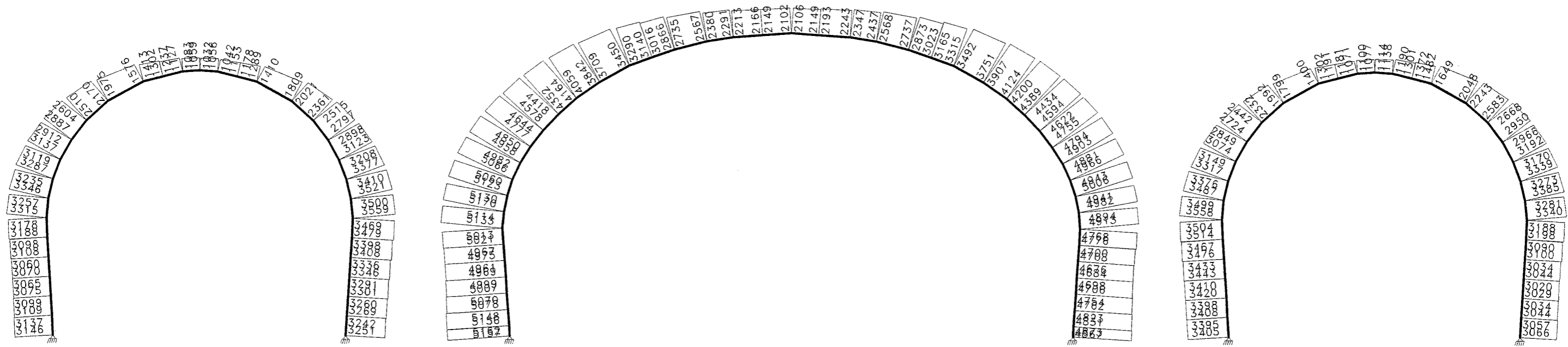

AXIAL FORCE COMB. NO. 6 Combinao FREQUENTE sem efeito hotel

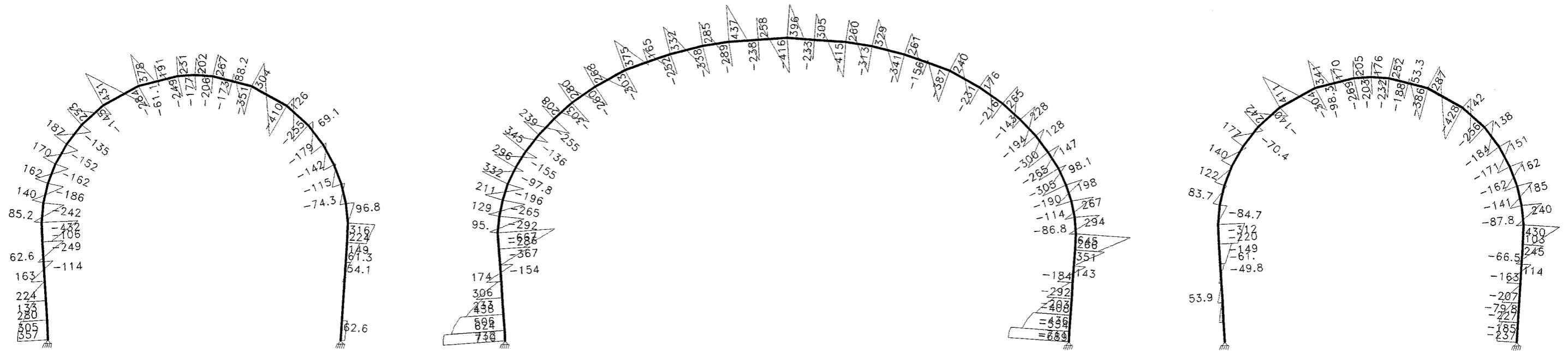

V2 SHEAR

COMB. NO. 6 Combinao FREQUENTE sem efeito hotel

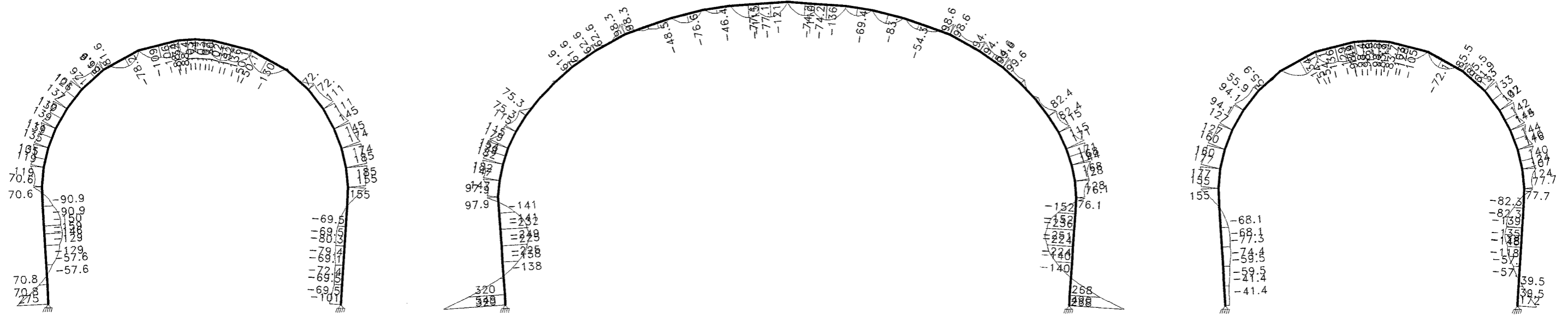
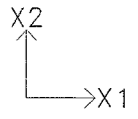

M3 MOMENT COMB. NO. 6 Combinao FREQUENTE sem efeito hotel

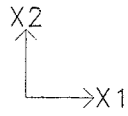

SCALE = 1:147

UNITS: meter

DATE:10-11-11

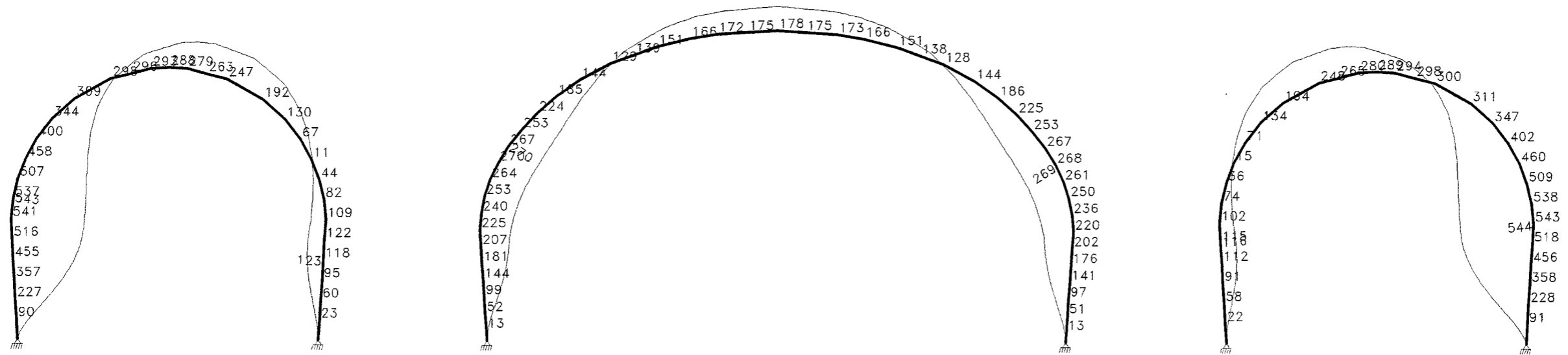

VALUES ARE * 10⁻⁸
 DISPLACEMENTS LOAD NO. 2 Cargo Unitrio

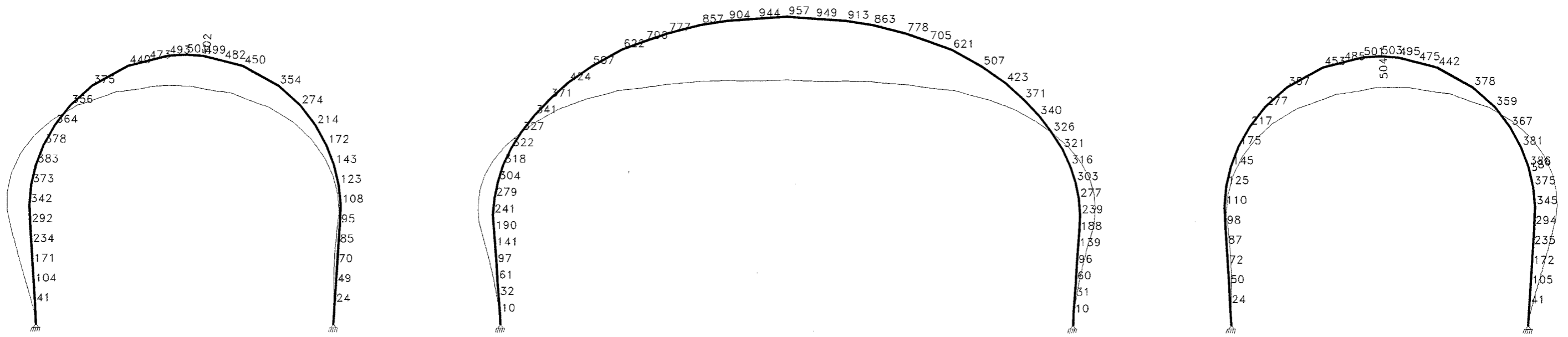

VALUES ARE * 10⁻⁵
DISPLACEMENTS LOAD NO. 1 P.P. Granito

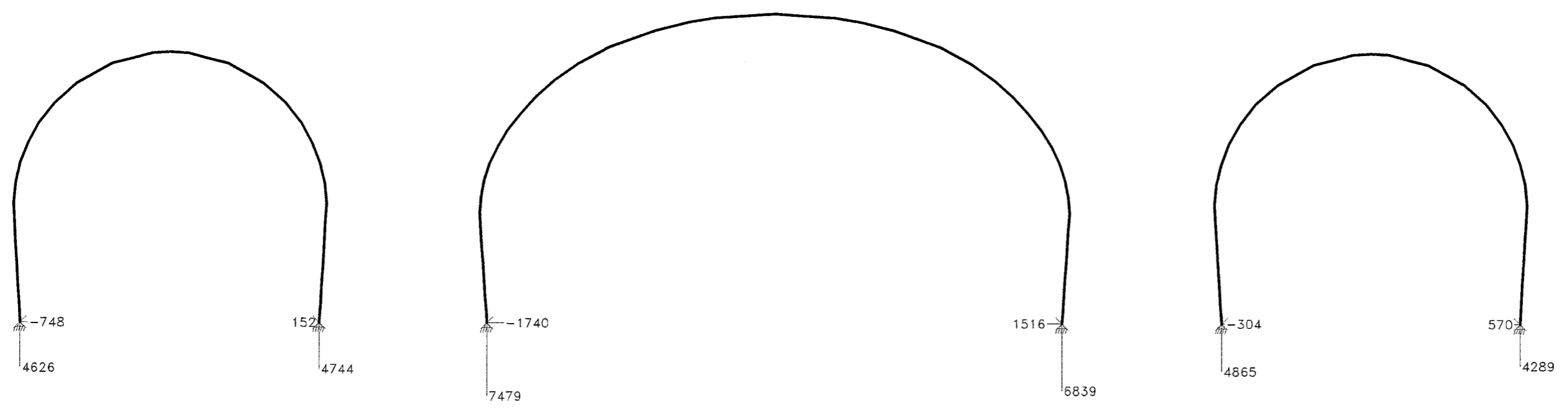
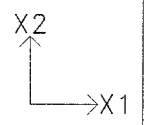

REACTIONS COMB. NO. 1 Combinao ELU1

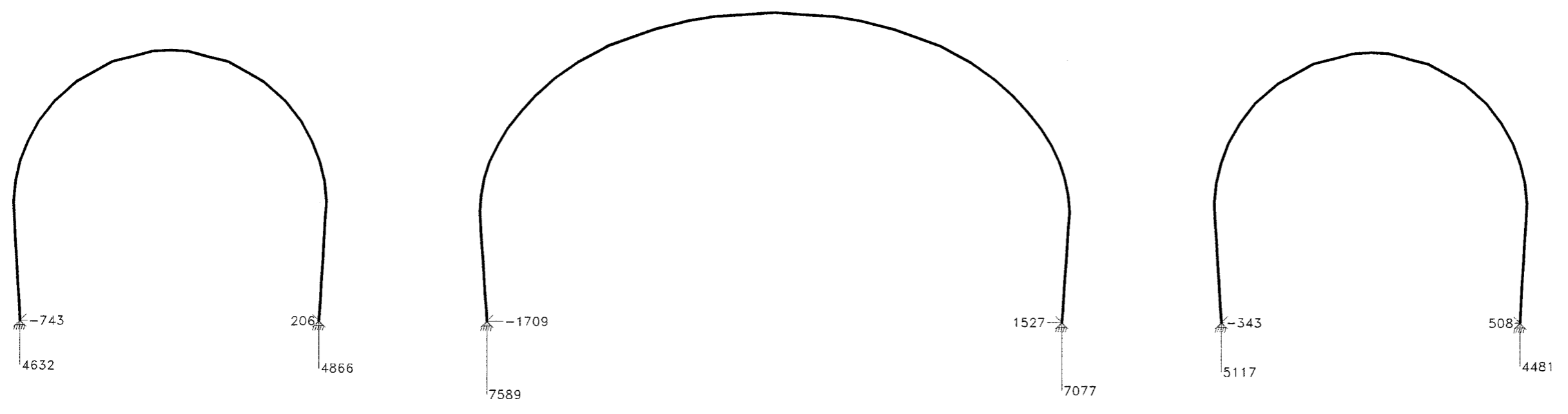
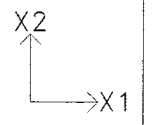

REACTIONS COMB. NO. 2 Combinao ELU2

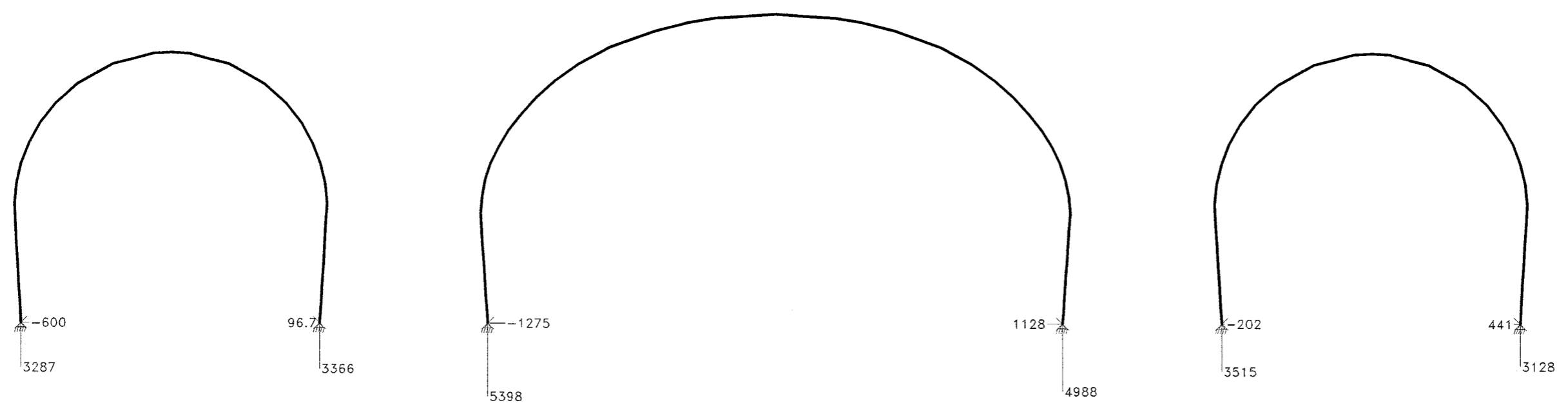
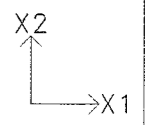

REACTIONS COMB. NO. 3 Combinao FREQUENTE1

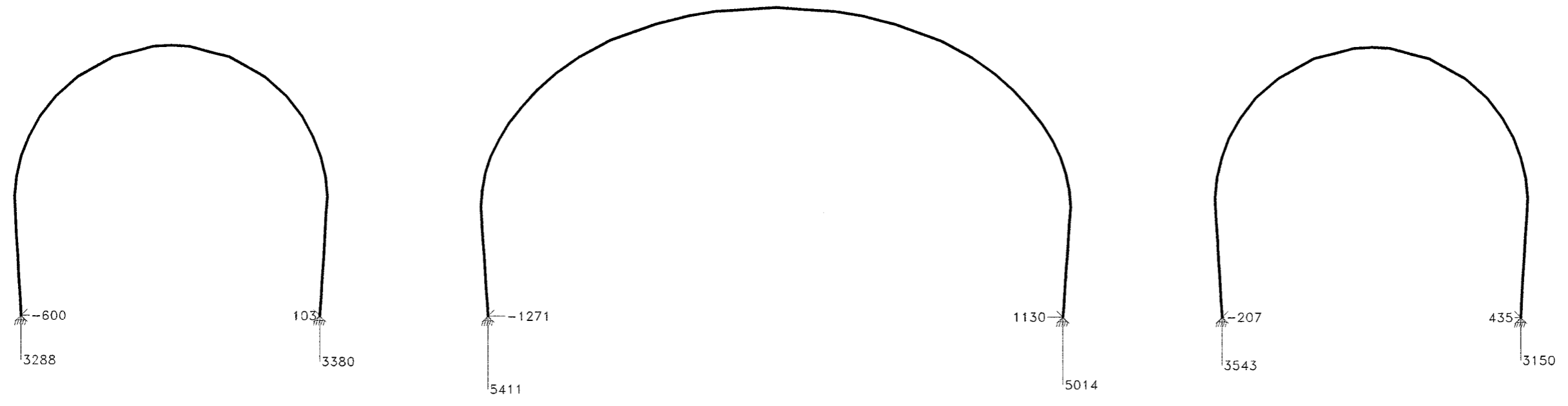
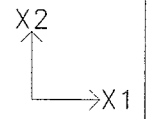

REACTIONS COMB. NO. 4 Combinao FREQUENTE2

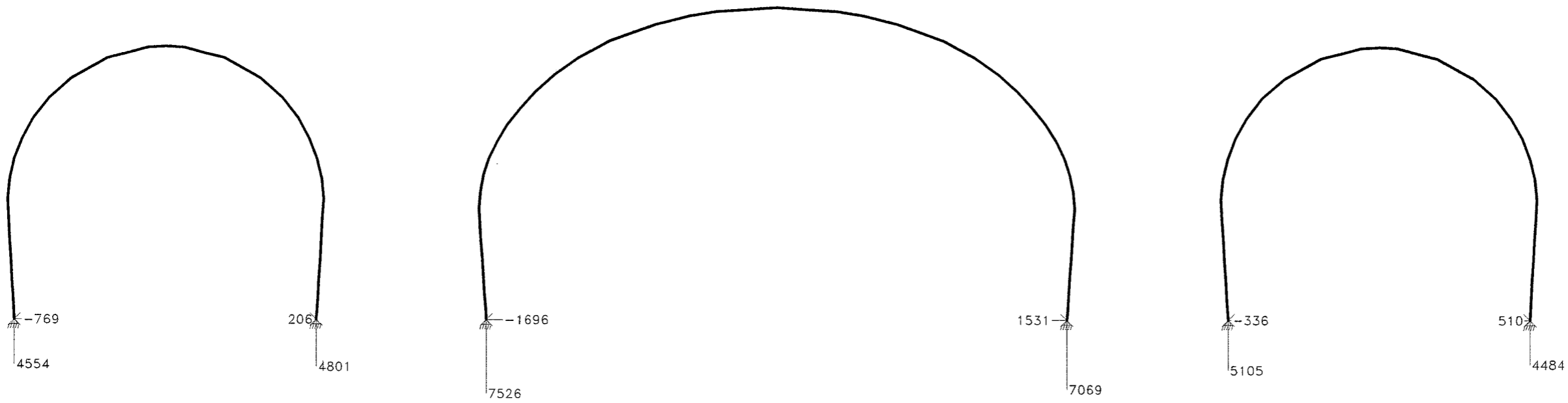
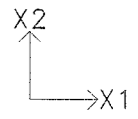

REACTIONS COMB. NO. 5 Combinao ELU1 sem efeito hotel

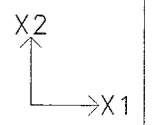

SCALE = 1:147

UNITS: kN

DATE:10-11-11

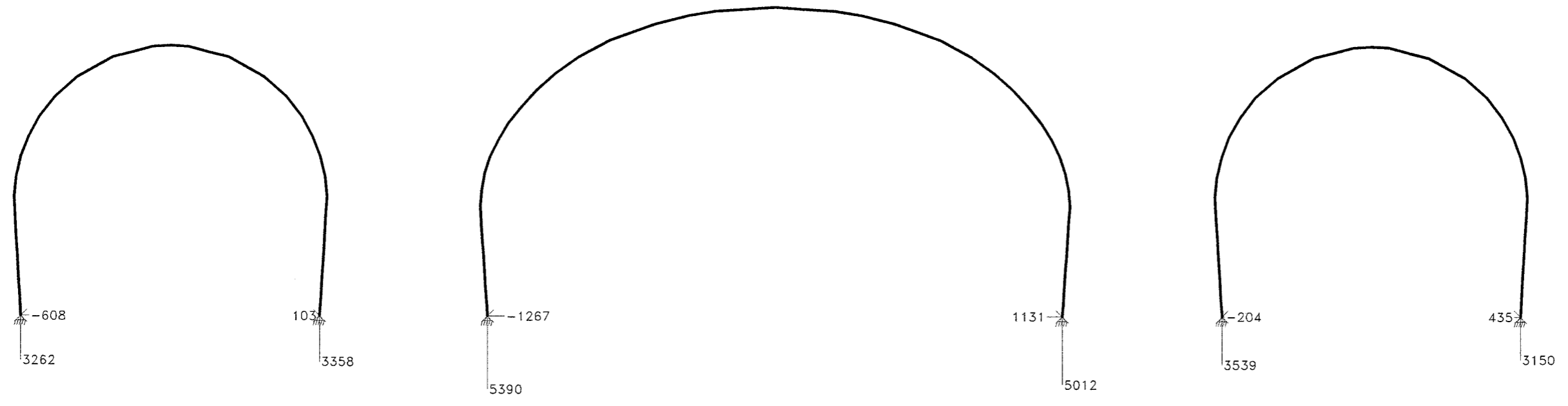

REACTIONS COMB. NO. 6 Combinao FREQUENTE sem efeito hotel

Tnel_0+750m

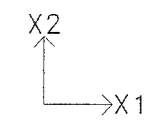

SCALE = 1:221

UNITS: kN m

DATE:10-11-11

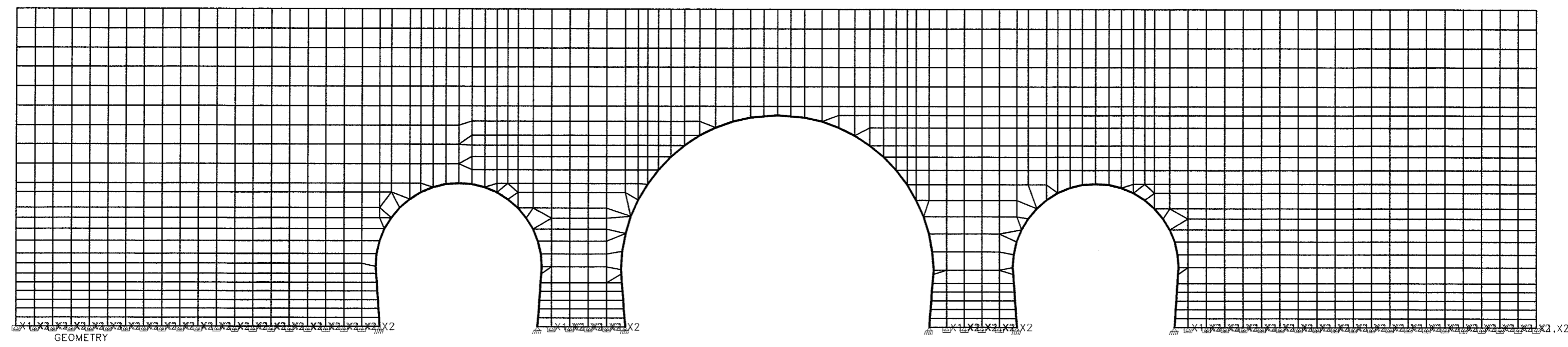

GEOMETRY

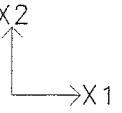

SCALE = 1:127

UNITS: kN

DATE:10-11-11

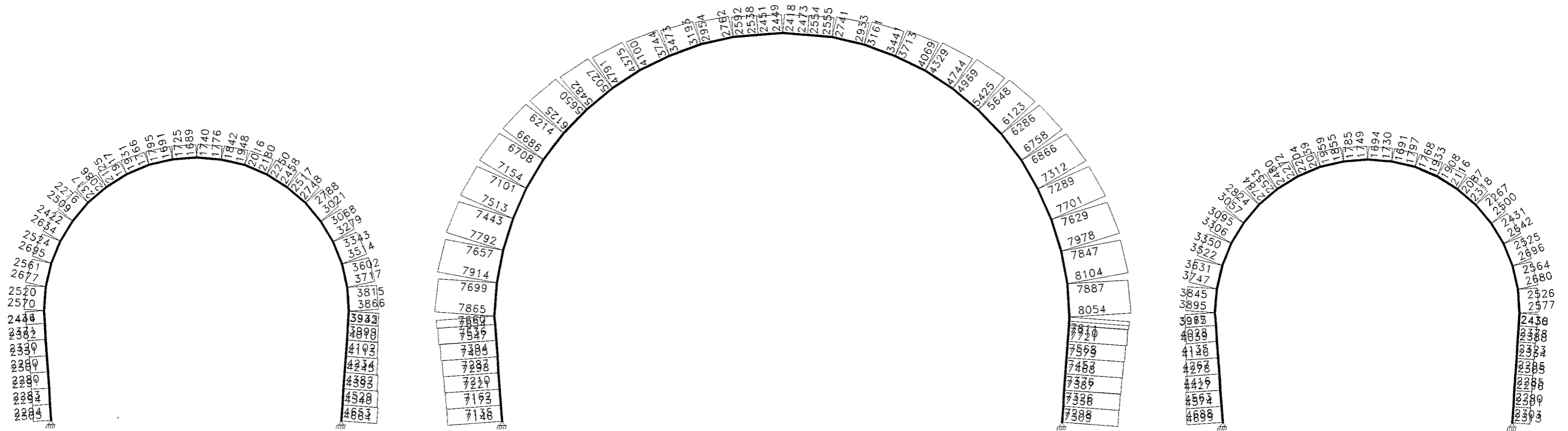

AXIAL FORCE COMB. NO. 1 Combinao ELU1

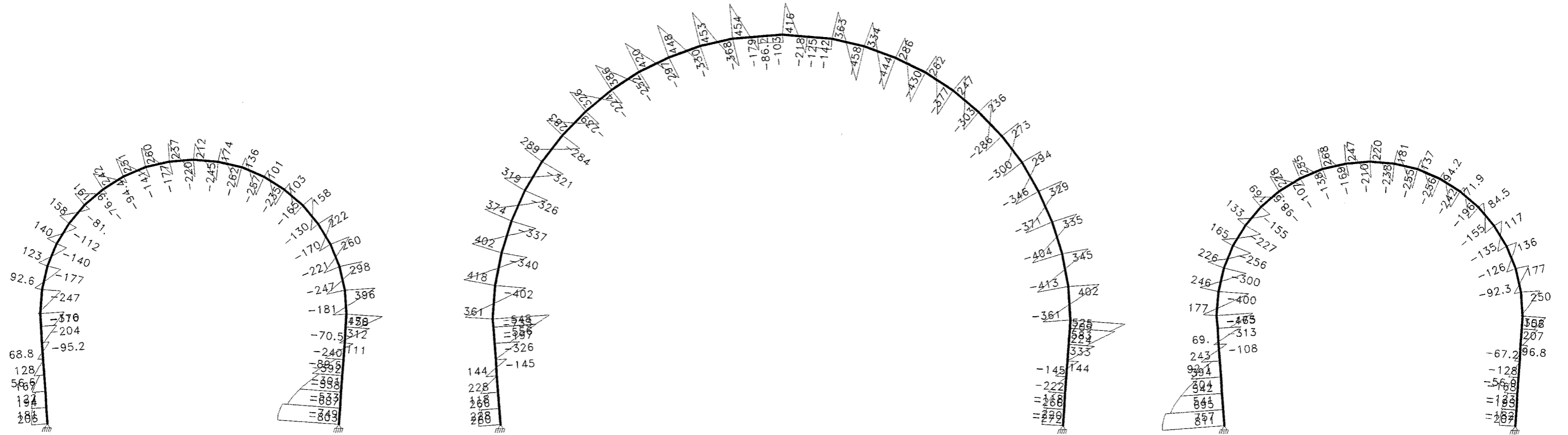

V2 SHEAR COMB. NO. 1 Combinao ELU1

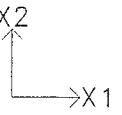

SCALE = 1:127

UNITS: kN*m

DATE:10-11-11

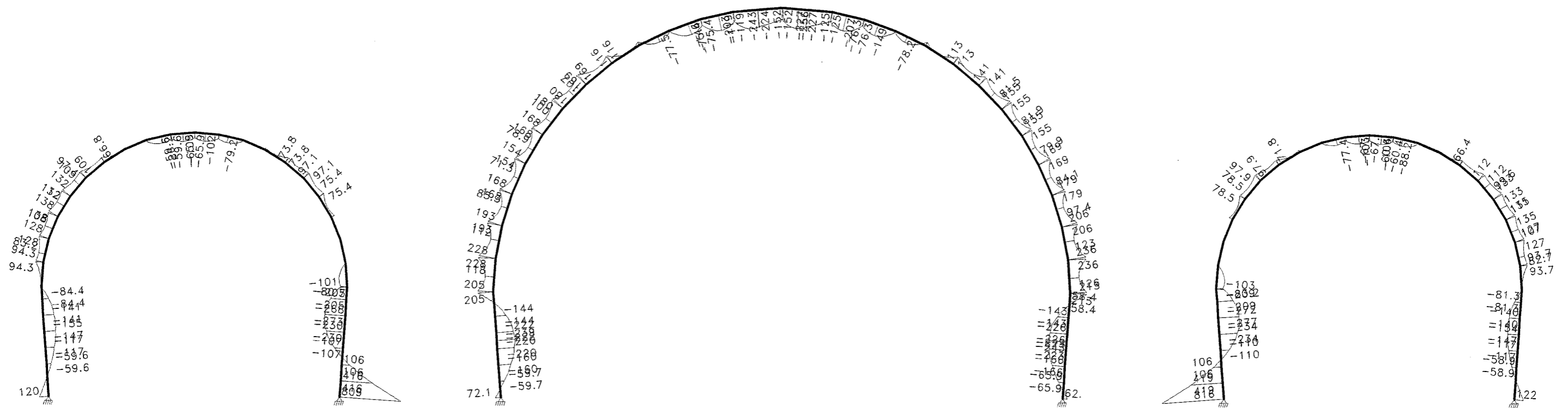

M3 MOMENT COMB. NO. 1 Combinao ELU1

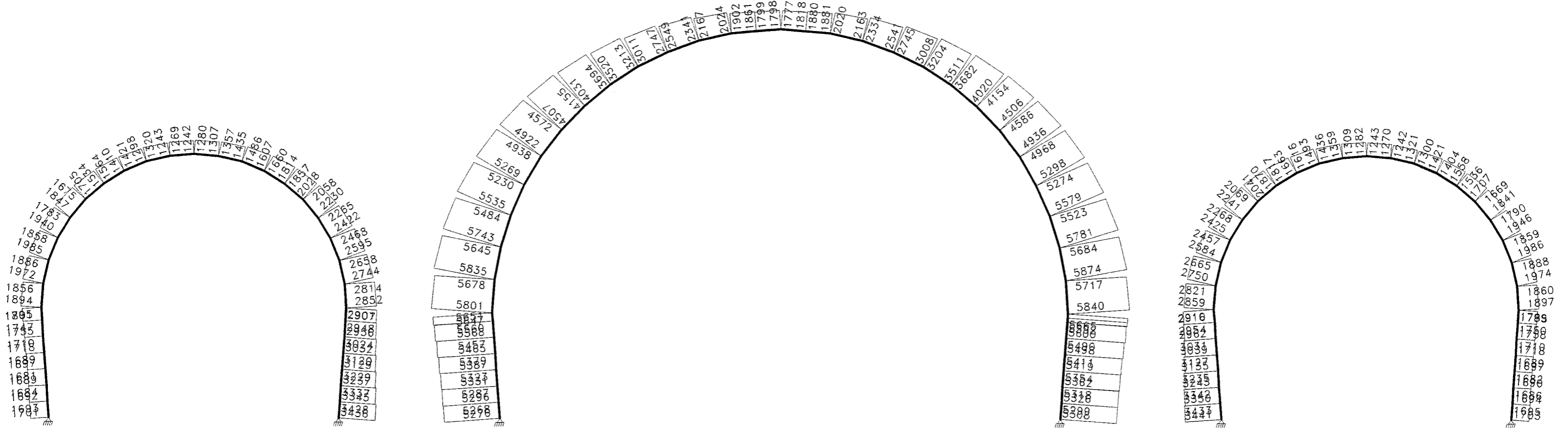

AXIAL FORCE COMB. NO. 2 Combinao FREQUENTE

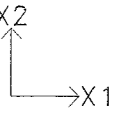

SCALE = 1:127

UNITS: kN

DATE:10-11-11

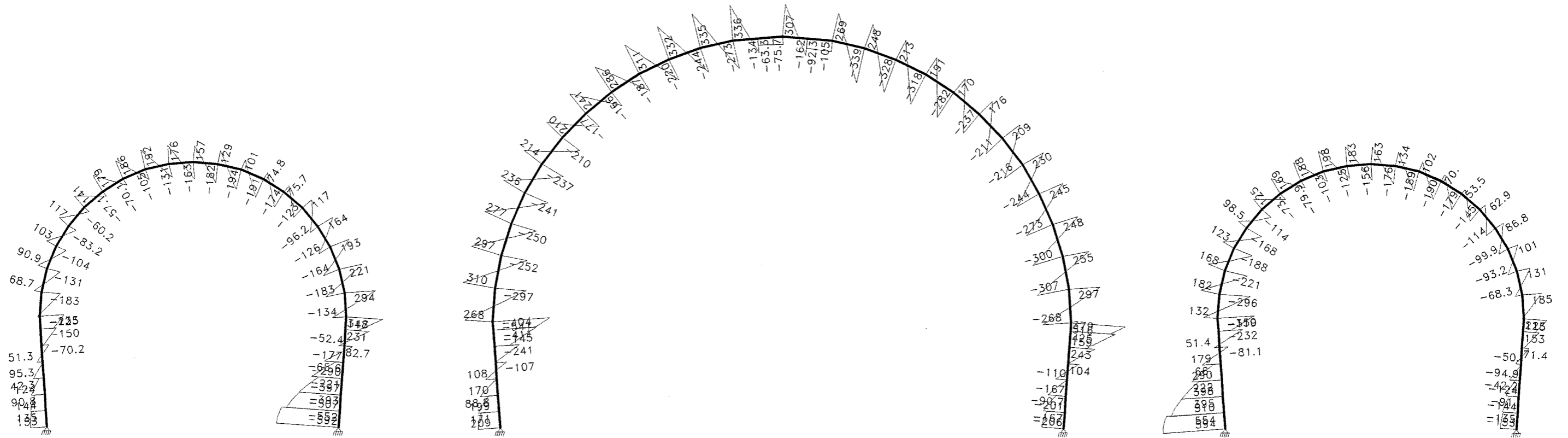

V2 SHEAR COMB. NO. 2 Combinao FREQUENTE

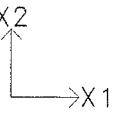

SCALE = 1:127

UNITS: kN*m

DATE:10-11-11

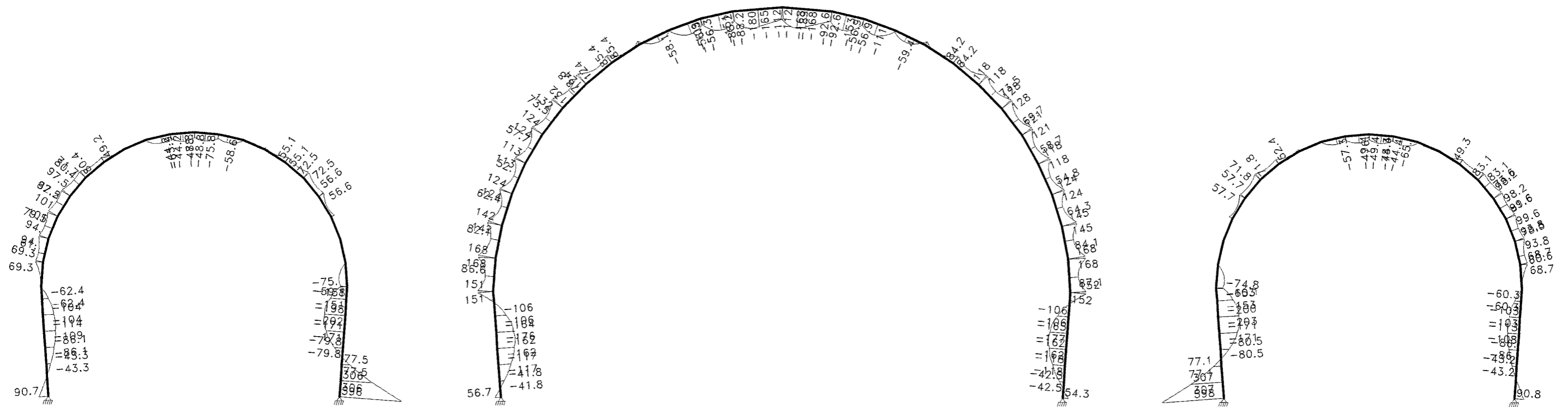

M3 MOMENT

COMB. NO. 2 Combinao FREQUENTE

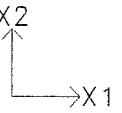

SCALE = 1:127

UNITS: meter

DATE:10-11-11

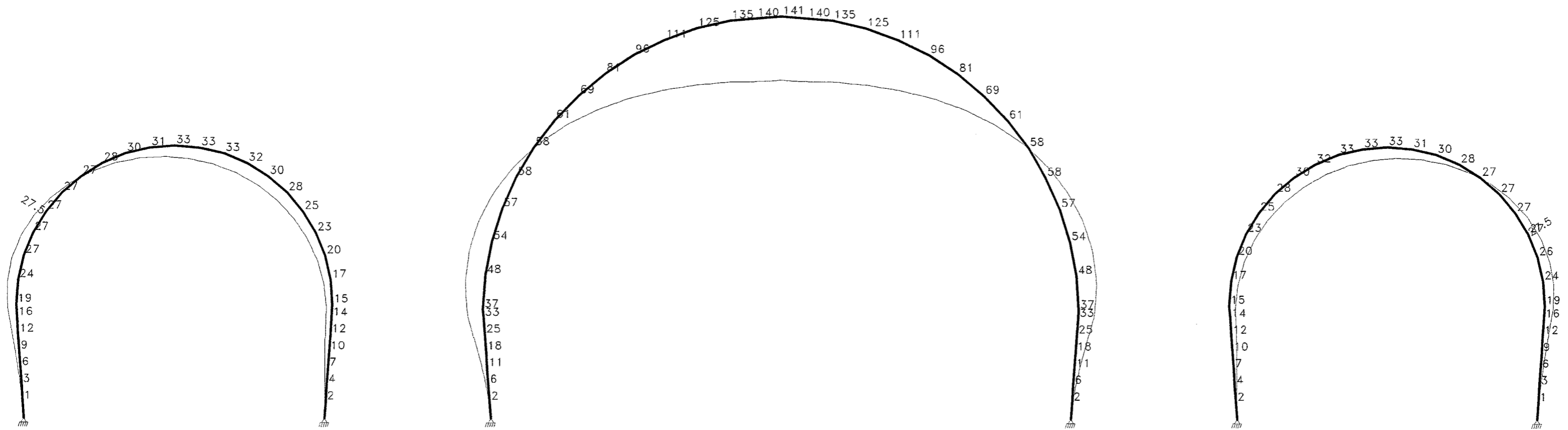

VALUES ARE * 10⁻⁴
DISPLACEMENTS LOAD NO. 1 PPGran

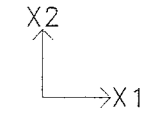

SCALE = 1:127

UNITS: meter

DATE:10-11-11

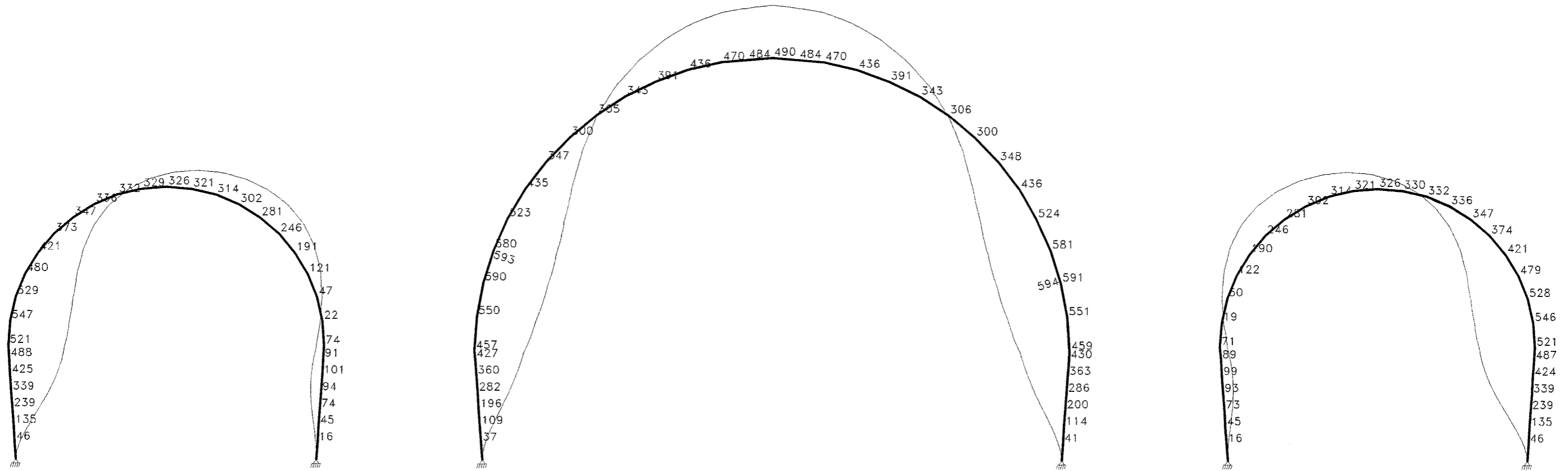

VALUES ARE * 10⁻⁸
DISPLACEMENTS LOAD NO. 2 Carga Unitria Horizontal

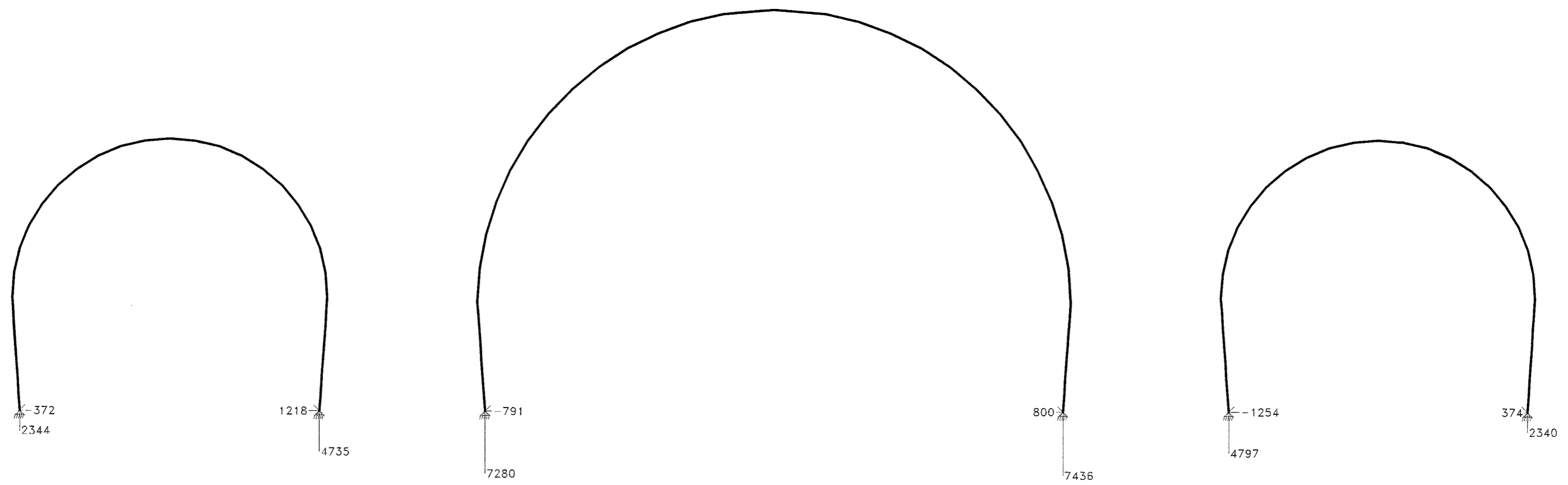
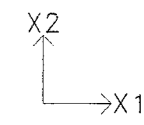

REACTIONS COMB. NO. 1 Combinao ELU1

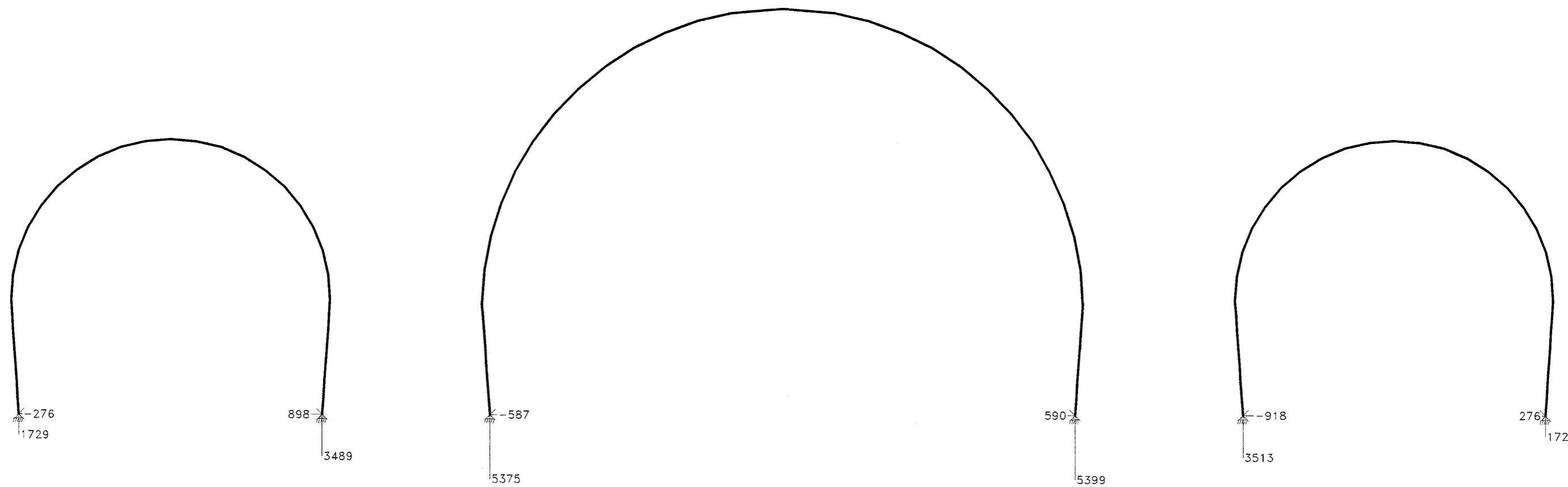
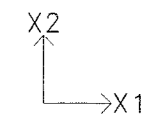

REACTIONS COMB. NO. 2 Combinao FREQUENTE

Secção 0+615m

vs= 0,3 m
 vi= 0,3 m
 b= 1 m
 h= 0,6 m
 I= 0,018 m⁴
 A= 0,6 m²

COMBINAÇÃO ELU					
	Nós	Esforços		Tensão Actuante (kPa)	
		N (kN)	M (kN.m)	Extradorso	Intradorso
Barra 1	1	-340	14,2	-803,33	-330,00
	2	-330	-0,5	-541,67	-558,33
Barra 7	1	-545	-12	-708,33	-1108,33
	2	-519,5	0,1	-867,50	-864,17
	3	-494	-16,5	-548,33	-1098,33
Barra 12	1	-357	-17	-311,67	-878,33
	2	-240,5	6,6	-510,83	-290,83
	3	-124	-17,8	90,00	-503,33
Barra 16	1	72	-19	436,67	-196,67
	2	90,5	21,5	-207,50	1511,67
	3	109	-19,1	500,00	-136,67

COMBINAÇÃO FREQUENTE

COMBINAÇÃO FREQUENTE					
	Nós	Esforços		Tensão Actuante (kPa)	
		N (kN)	M (kN.m)	Extradorso	Intradorso
Barra 1	1	-230	5	-466,67	-300,00
	2	-223	-1,3	-350,00	-393,33
Barra 7	1	-369	-8	-481,67	-748,33
	2	-350	1,1	-601,67	-565,00
	3	-331	11,1	-736,67	-366,67
Barra 12	1	-253	-12,4	-215,00	-628,33
	2	-166,5	4,9	-359,17	-195,83
	3	-80	-13,3	88,33	-355,00
Barra 16	1	45,6	-14,5	317,67	-165,67
	2	59,1	15,4	-158,17	355,17
	3	72,6	-14,6	364,33	-122,33

Secção 0+627m

vs= 0,3 m
 vi= 0,3 m
 b= 1 m
 h= 0,6 m
 I= 0,018 m⁴
 A= 0,6 m²

COMBINAÇÃO ELU					
	Nós	Esforços		Tensão Actuante (kPa)	
		N (kN)	M (kN.m)	Extradorso	Intradorso
Barra 1	1	-466	24,7	-1188,33	-365,00
	2	-455	-6,8	-645,00	-871,67
Barra 7	1	-741	-15,5	-976,67	-1493,33
	2	-677	7,5	-1253,33	-1003,33
	3	-677	-24,3	221,67	-1533,33
Barra 12	1	-575	-25,6	-105,00	-425,00
	2	-407	9	-828,33	-528,33
	3	-239	-28,5	-398,33	-873,33
Barra 17	1	96,6	-37	161,00	-455,67
	2	120,3	30	-299,50	700,50
	3	144	-37,2	240,00	-380,00

COMBINAÇÃO FREQUENTE

COMBINAÇÃO FREQUENTE					
	Nós	Esforços		Tensão Actuante (kPa)	
		N (kN)	M (kN.m)	Extradorso	Intradorso
Barra 1	1	-326	13,6	-770,00	-316,67
	2	-318	-4,7	-451,67	-608,33
Barra 7	1	-511	-11,1	-666,67	-1036,67
	2	-487,5	6	-912,50	-712,50
	3	-464	-17,5	-481,67	-1065,00
Barra 12	1	-410	-18,9	-368,33	-998,33
	2	-285,5	6,7	-587,50	-364,17
	3	-161	-21,1	83,33	-620,00
Barra 16	1	62,2	-26,2	540,33	-333,00
	2	79,9	20,7	-211,83	478,17
	3	97,6	-27,8	626,00	-300,67

Secção 0+668m

vs= 0,3 m
 vi= 0,3 m
 b= 1 m
 h= 0,6 m
 I= 0,018 m⁴
 A= 0,6 m²

COMBINAÇÃO ELU					
	Nós	Esforços		Tensão Actuante (kPa)	
		N (kN)	M (kN.m)	Extradorso	Intradorso
Barra 1	1	-551	33,1	-1470,00	-366,67
	2	-540	-9,5	-741,67	-1058,33
Barra 6	1	-779	-6	-965,00	-1398,33
	2	-774	1,1	-1308,33	-1271,67
	3	-769	-20	-1261,67	-1615,00
Barra 12	1	-790	-30,6	-296,67	-1826,67
	2	-610,5	6,7	-1129,17	-905,83
	3	-431	-33,7	-718,33	-1280,00
Barra 17	1	79	-40,3	131,67	-540,00
	2	104	33	-376,67	723,33
	3	129	-40,4	215,00	-458,33
Barra 34	1	-1038	5,7	-1825,00	-1635,00
	2	-1049	-32,7	-1748,33	-2293,33
Barra 29	1	-1119	-10,6	-1865,00	-2041,67
	2	-1129	2,1	-1916,67	-1846,67
Barra 23	1	-346	-26,4	-576,67	-1016,67
	2	-540,5	11,1	-1085,83	-715,83
	3	-735	-24,6	-1225,00	-1635,00
Barra 18	1	-156	-40,4	-260,00	-933,33
	2	-131	33,5	-776,67	340,00
	3	-106	-39,4	-176,67	-833,33

COMBINAÇÃO FREQUENTE

COMBINAÇÃO FREQUENTE					
	Nós	Esforços		Tensão Actuante (kPa)	
		N (kN)	M (kN.m)	Extradorso	Intradorso
Barra 1	1	-393	17,1	-940,00	-370,00
	2	-385	-6,4	-535,00	-748,33
Barra 7	1	-627	-15	-795,00	-1295,00
	2	-603	9,8	-1168,33	-841,67
	3	-579	-23,6	-571,67	-1358,33
Barra 12	1	-563	-22,6	-561,67	-1315,00
	2	-430	5	-800,00	-633,33
	3	-297	-24,9	-80,00	-910,00
Barra 17	1	50,4	-30,3	589,00	-421,00
	2	68,9	24	-285,17	514,83
	3	87,4	-30,3	650,67	-359,33
Barra 34	1	-726	3,9	-1275,00	-1145,00
	2	-734	-23	-840,00	-1606,67
Barra 29	1	-782	-7,6	-1176,67	-1430,00
	3	-789	1,43	-1338,83	-1291,17
	1	-233	-19,6	-61,67	-715,00
Barra 23	2	-366,5	8,2	-747,50	-474,17
	3	-500	-18,1	-531,67	-1135,00
	1	107	-30,3	683,33	-326,67
Barra 18	2	88,35	24,4	-259,42	553,92
	3	69,7	-29,6	609,50	-377,17

Secção 0+678m

vs= 0,3 m
 vi= 0,3 m
 b= 1 m
 h= 0,6 m
 I= 0,018 m⁴
 A= 0,6 m²

COMBINAÇÃO ELU

Galeria Ascendente					
	Nós	Esforços		Tensão Actuante (kPa)	
		N (kN)	M (kN.M)	Extradorso	Intradorso
Barra 1	1	-227	20,7	-723,33	-33,33
	2	-217	-2,8	-315,00	-408,33
Barra 7	1	-343	-0,6	-561,67	-581,67
	2	-339	0,44	-572,33	-557,67
	3	-335	-5,1	-473,33	-643,33
Barra 12	1	-341	-12,5	-360,00	-776,67
	2	-288	-3,3	-425,00	-535,00
	3	-235	-6,8	-278,33	-505,00
Barra 16	1	-7,5	1,8	-42,50	17,50
	2	1,75	13,9	-228,75	234,58
	3	11	2,9	-30,00	66,67
Barra 33	1	-434	0,5	-731,67	-715,00
	2	-444	-16,2	-470,00	-1010,00
Barra 26	1	-429	-4,1	-783,33	-646,67
	2	-437	-0,4	-721,67	-735,00
Barra 21	1	-181	-3	-351,67	-251,67
	2	-234	1,1	-371,67	-408,33
	3	-287	-6,8	-591,67	-365,00
Barra 17	1	26,3	2,9	-4,50	92,17
	2	17,15	14,4	-211,42	268,58
	3	8	2,8	-33,33	60,00

COMBINAÇÃO ELU

Galeria Ascendente					
	Nós	Esforços		Tensão Actuante (kPa)	
		N (kN)	M (kN.M)	Extradorso	Intradorso
Barra 1	1	-207	5	-428,33	-261,67
	2	-197	-2,1	-293,33	-363,33
Barra 7	1	-277	-0,1	-460,00	-463,33
	2	-273	1,21	-475,17	-434,83
	3	-269	-3,73	-386,17	-510,50
Barra 12	1	-303	-11,3	-316,67	-693,33
	2	-250	-2,8	-370,00	-463,33
	3	-197	-6,8	-215,00	-441,67
Barra 16	1	-28,4	-0,3	-52,33	-42,33
	2	-19,15	11,7	-226,92	163,08
	3	-9,9	0,8	-29,83	-3,17
Barra 33	1	-371	-14,4	-858,33	-378,33
	2	-381	0	-635,00	-635,00
Barra 26	1	-363	3,33	-660,50	-549,50
	2	-367	0,37	-617,83	-605,50
	3	-371	-0,3	-613,33	-623,33
Barra 21	1	-152	-3,4	-310,00	-196,67
	2	-205	1,2	-321,67	-361,67
	3	-258	6	-530,00	-330,00
Barra 17	1	3,9	0,8	-6,83	19,83
	2	-6,75	12,2	-214,58	192,08
	3	-17,4	-1	-45,67	-12,33

Galeria Central Ascendente

	Nós	Esforços		Tensão Actuante (kPa)	
		N (kN)	M (kN.M)	Extradorso	Intradorso
Barra 34	1	-396	-8,2	-523,33	-796,67
	2	-386	1,3	-665,00	-621,67
Barra 40	1	-468	0,87	-794,50	-765,50
	2	-460	-6,5	-658,33	-875,00
Barra 45	1	-324	-9,6	-380,00	-700,00
	2	-271	-1	-435,00	-468,33
	3	-218	-4,7	-285,00	-441,67
Barra 49	1	0,1	3,1	-51,50	51,83
	2	9,25	14,8	-231,25	262,08
	3	18,4	3,4	-26,00	87,33
Barra 65	1	-361	2,1	-636,67	-566,67
	2	-371	-9,7	-456,67	-780,00
Barra 59	1	-404	-3,5	-615,00	-731,67
	2	-412	0,33	-692,17	-681,17
Barra 54	1	-238	-4,2	-326,67	-466,67
	2	-291	-0,8	-471,67	-498,33
	3	-344	-8,7	-428,33	-718,33
Barra 50	1	16,9	3,4	-28,50	84,83
	2	7,6	14,5	-229,00	254,33
	3	-1,7	2,5	-44,50	38,83

Galeria Central Ascendente

	Nós	Esforços		Tensão Actuante (kPa)	
		N (kN)	M (kN.M)	Extradorso	Intradorso
Barra 34	1	-344	-7,5	-448,33	-698,33
	2	-334	0,88	-571,33	-542,00
Barra 40	1	-404	0,68	-684,67	-662,00
	2	-396	-5,77	-563,83	-756,17
Barra 45	1	-291	-8,97	-335,50	-634,50
	2	-238	-1	-380,00	-413,33
	3	-185	-4,8	-228,33	-388,33
Barra 49	1	2	1,3	-18,33	25,00
	2	11,1	13	-198,17	235,17
	3	20,2	1,5	8,67	58,67
Barra 65	1	-332	1,9	-585,00	-521,67
	2	-342	-11,5	-378,33	-761,67
Barra 59	1	-356	-2,8	-546,67	-640,00
	2	-364	0,48	-614,67	-598,67
Barra 54	1	-203	-4	-271,67	-405,00
	2	-256,5	-0,8	-414,17	-440,83
	3	-310	-7,6	-390,00	-643,33
Barra 50	1	1,5	1,5	-22,50	27,50
	2	12,8	12,8	-192,00	234,67
	3	2	1	-13,33	20,00

COMBINAÇÃO FREQUENTE

Galeria Ascendente					
	Nós	Esforços		Tensão Actuante (kPa)	
		N (kN)	M (kN.M)	Extradorso	Intradorso
Barra 1	1	-152	7,2	-373,33	-133,33
	2	-144	-1,8	-210,00	-270,00
Barra 7	1	-212	-0,2	-350,00	-356,67
	2	-209	0,74	-360,67	-336,00
	3	-206	-3	-293,33	-393,33
Barra 12	1	-227	-8,6	-235,00	-521,67
	2	-187,5	-2,2	-275,83	-349,17
	3	-148	-5,5	-155,00	-338,33
Barra 16	1	-13,5	0,1	-24,17	-20,83
	2	-6,6	9,1	-162,67	140,67
	3	0,3	0,8	-12,83	13,83
Barra 33	1	-278	0	-463,33	-463,33
	2	-285	-10,6	-298,33	-651,67
Barra 26	1	-274	-2,6	-413,33	-500,00
	2	-277	0,19	-464,83	-458,50
	3	-280	-0,2	-463,33	-470,00
Barra 21	1	-113	-2,5	-146,67	-230,00
	2	-152,5	0,84	-268,17	-240,17
	3	-192	-4,7	-241,67	-398,33
Barra 17	1	10,7	0,82	4,17	31,50
	2	3,85	9,4	-150,25	163,08
	3	-3	0,88	-19,67	9,67

COMBINAÇÃO FREQUENTE

Galeria Ascendente					
	Nós	Esforços		Tensão Actuante (kPa)	
		N (kN)	M (kN.M)	Extradorso	Intradorso
Barra 1	1	-147	4,1	-313,33	-176,67
	2	-140	-1,6	-206,67	-260,00
Barra 7	1	-198	-0,2	-326,67	-333,33
	2	-195	0,9	-340,00	-310,00
	3	-192	-2,71	-274,83	-365,17
Barra 12	1	-218	-8,3	-225,00	-501,67
	2	-179	-2,1	-263,33	-333,33
	3	-140	-5,5	-141,67	-325,00
Barra 16	1	-17,3	-0,29	-33,67	-24,00
	2	-10,9	8,61	-161,67	125,33
	3	-4,5	0,8	-20,83	5,83
Barra 33	1	-264	0	-440,00	-440,00
	2	-272	-10,1	-285,00	-621,67
Barra 26	1	-260	-2,4	-393,33	-473,33
	2	-273	0,25	-459,17	-450,83
	3	-286	-0,2	-473,33	-480,00
Barra 21	1	-107	-2,5	-136,67	-220,00
	2	-146	0,87	-257,83	-228,83
	3	-185	-4,48	-233,67	-383,00
Barra 17	1	6,58	0,2	7,63	14,30
	2	-0,295	8,98	-150,16	149,18
	3	-7,17	1	-28,62	4,72

Galeria Central Ascendente

	Nós	Esforços		Tensão Actuante (kPa)	
		N (kN)	M (kN.M)	Extradorso	Intradorso
Barra 34	1	-259	-5,8	-335,00	-528,33
	2	-251	0,69	-429,83	-406,83
Barra 40	1	-302	0,54	-512,33	-494,33
	2	-296	-4,32	-421,33	-565,33
Barra 45	1	-215	-6,6	-248,33	-468,33
	2	-175,5	-0,5	-284,17	-300,83
	3	-136	-3,5	-168,33	-285,00
Barra 49	1	-4,8	1,2	-28,00	12,00
	2	2	9,8	-160,00	166,67
	3	8,8	1,3	-7,00	36,33
Barra 65	1	-238	-7,1	-278,33	-515,00
	2	-245	1,4	-385,00	-431,67
Barra 59	1	-261	-2,1	-400,00	-470,00
	2	-267	0,4	-451,67	-438,33
Barra 54	1	-151	-3,1	-200,00	-303,33
	2	-190	-0,2	-313,33	-320,00
	3	-229	-5,8	-285,00	-478,33
Barra 50	1	8,1	1,3	-8,17	35,17
	2	1,25	9,7	-159,58	163,75
	3	-5,6	0,85	-23,50	4,83

Galeria Central Ascendente

	Nós	Esforços		Tensão Actuante (kPa)	
		N (kN)	M (kN.M)	Extradorso	Intradorso
Barra 34	1	-248	-5,7	-318,33	-508,33
	2	-240	0,57	-409,50	-390,50
Barra 40	1	-288	0,48	-488,00	-472,00
	2	-283	-4,13	-402,83	-540,50
Barra 45	1	-207	-6,5	-236,67	-453,33
	2	-168	-0,5	-271,67	-288,33
	3	-129	-3,5	-156,67	-273,33
Barra 49	1	-7,39	0,78	-25,32	0,68
	2	-0,525	9,4	-157,54	155,79
	3	6,34	0,93	-4,93	26,07
Barra 65	1	-230	-7,3	-261,67	-505,00
	2	-238	1,3	-375,00	-418,33
Barra 59	1	-250	-2,2	-380,00	-453,33
	2	-256	0,2	-430,00	-423,33
Barra 54	1	-143	-3,1	-186,67	-290,00
	2	-182,5	-0,1	-302,50	-305,83
	3	-222	-5,6	-276,67	-463,33
Barra 50	1	5,75	0,93	-5,92	25,08
	2	1,76	9,3	-152,07	157,93
	3	-7,98	0,8	-26,63	0,03

Secção 0+699m

vs= 0,3 m
 vi= 0,3 m
 b= 1 m
 h= 0,6 m
 I= 0,018 m⁴
 A= 0,6 m²

COMBINAÇÃO ELU

Galeria Ascendente					
	Nós	Esforços		Tensão Actuante (kPa)	
		N (kN)	M (kN.M)	Extradorso	Intradorso
Barra 1	1	-231	22,8	-765,00	-5,00
	2	-222	-2	-336,67	-403,33
Barra 8	1	-387	0,1	-646,67	-643,33
	2	-382	1,4	-660,00	-613,33
	3	-377	-8,8	-481,67	-775,00
Barra 13	1	-359	-12,2	-395,00	-801,67
	2	-280	0,7	-478,33	-455,00
	3	-201	-8,7	-190,00	-480,00
Barra 17	1	33,9	-5,2	-30,17	143,17
	2	65,3	16,8	-171,17	388,83
	3	60,9	-5,1	186,50	16,50
Barra 34	1	-310	-1	-533,33	-500,00
	2	-318	-8,2	-393,33	-666,67
Barra 27	1	-401	-7	-551,67	-785,00
	2	-411	1,8	-715,00	-655,00
Barra 22	1	-172	-8,4	-146,67	-426,67
	2	-251	2,3	-456,67	-380,00
	3	-330	-9,6	-390,00	-710,00
Barra 18	1	66,1	-5,1	195,17	25,17
	2	52,65	16,8	-192,25	367,75
	3	39,2	-5,4	155,33	-24,67

Galeria Central Ascendente

	Nós	Esforços		Tensão Actuante (kPa)	
		N (kN)	M (kN.M)	Extradorso	Intradorso
Barra 35	1	-297	-10,8	-315,00	-675,00
	2	-298	-1,3	-475,00	-518,33
Barra 42	1	-357	1,8	-625,00	-565,00
	2	350	-4,9	665,00	501,67
Barra 47	1	-281	-4,8	-388,33	-548,33
	2	-237	0,82	-408,67	-381,33
	3	-193	-3,2	-268,33	-375,00
Barra 51	1	-22,4	2,9	-85,67	11,00
	2	-14,9	12,5	-233,17	183,50
	3	-7,4	3,4	-69,00	44,33
Barra 52	1	-6	3,4	-66,67	46,67
	2	-13,65	12,5	-231,08	185,58
	3	-21,3	3	-85,50	14,50
Barra 56	1	-185	-4,7	-230,00	-386,67
	2	-229,5	-1,2	-362,50	-402,50
	3	-274	-7,3	-335,00	-578,33
Barra 61	1	-340	-3,9	-501,67	-631,67
	2	-347	0,05	-579,17	-577,50
Barra 68	1	-302	-0,5	-495,00	-511,67
	2	-310	-7	-400,00	-633,33

COMBINAÇÃO ELU

Galeria Ascendente					
	Nós	Esforços		Tensão Actuante (kPa)	
		N (kN)	M (kN.M)	Extradorso	Intradorso
Barra 1	1	-214	12,2	-560,00	-153,33
	2	-206	1,8	-313,33	-373,33
Barra 8	1	-334	0,5	-565,00	-548,33
	2	-329	1,8	-578,33	-518,33
	3	-324	-7,7	-411,67	-668,33
Barra 13	1	-336	-11,8	-363,33	-756,67
	2	-257	0,9	-443,33	-413,33
	3	-178	-8,9	-148,33	-445,00
Barra 17	1	13,1	-6,5	-86,50	130,17
	2	26,6	15,5	-214,00	302,67
	3	40,1	-6,5	175,17	-41,50
Barra 34	1	-281	-1,4	-491,67	-445,00
	2	-290	-9,5	-325,00	-641,67
Barra 27	1	-358	-6,2	-493,33	-700,00
	2	-368	1,7	-641,67	-585,00
Barra 22	1	-151	-8,3	-113,33	-390,00
	2	-180	2,5	-341,67	-258,33
	3	-209	-9,2	-195,00	-501,67
Barra 18	1	45,5	-6,5	184,17	-32,50
	2	32	15,5	-205,00	311,67
	3	18,5	-6,5	139,17	-77,50

Galeria Central Ascendente

	Nós	Esforços		Tensão Actuante (kPa)	
		N (kN)	M (kN.M)	Extradorso	Intradorso
Barra 35	1	-270	-7,7	-321,67	-578,33
	2	-261	-1	-418,33	-451,67
Barra 42	1	-334	1,7	-585,00	-528,33
	2	-327	-4,6	-468,33	-621,67
Barra 47	1	-276	-5,1	-375,00	-545,00
	2	-232	0,42	-393,67	-379,67
	3	-188	-3,7	-251,67	-375,00
Barra 51	1	-26	2,2	-80,00	-6,67
	2	-18,5	11,9	-229,17	167,50
	3	-11	2,9	-66,67	30,00
Barra 52	1	-7	2,9	-60,00	36,67
	2	-14,5	12,1	-225,83	177,50
	3	-22	2,7	-81,67	8,33
Barra 56	1	-171	-4,3	-213,33	-356,67
	2	-215	-0,5	-350,00	-366,67
	3	-259	-6,7	-320,00	-543,33
Barra 61	1	-331	-3,6	-491,67	-611,67
	2	-338	0,19	-566,50	-560,17
Barra 68	1	-306	-0,99	-493,50	-526,50
	2	-314	-9,3	-368,33	-678,33

COMBINAÇÃO FREQUENTE

Galeria Ascendente					
	Nós	Esforços		Tensão Actuante (kPa)	
		N (kN)	M (kN.M)	Extradorso	Intradorso
Barra 1	1	-157	9,7	-423,33	-100,00
	2	-150	-1,4	-226,67	-273,33
Barra 8	1	-247	0,1	-413,33	-410,00
	2	-243,5	1,3	-427,50	-384,17
	3	-240	-5,7	-305,00	-495,00
Barra 13	1	-246	-8,7	-265,00	-555,00
	2	-187	0,7	-323,33	-300,00
	3	-128	-6,6	-103,33	-323,33
Barra 17	1	16	-4,7	105,00	-51,67
	2	26	11,6	-150,00	236,67
	3	36	-4,7	138,33	-18,33
Barra 34	1	-200	-5,3	-245,00	-421,67
	2	-206	-0,8	-330,00	-356,67
Barra 27	1	-260	-4,6	-356,67	-510,00
	2	-268	1,2	-466,67	-426,67
Barra 22	1	-109	-6,9	-66,67	-296,67
	2	-167,5	-2	-245,83	-312,50
	3	-226	-8,4	-236,67	-516,67
Barra 18	1	39,6	-4,7	144,33	-12,33
	2	29,6	11,6	-144,00	242,67
	3	19,6	-4,8	112,67	-47,33

COMBINAÇÃO FREQUENTE

Galeria Ascendente					
	Nós	Esforços		Tensão Actuante (kPa)	
		N (kN)	M (kN.M)	Extradorso	Intradorso
Barra 1	1	-153	-7,4	-131,67	-378,33
	2	-147	1,3	-266,67	-223,33
Barra 8	1	-235	0,5	-383,33	-400,00
	2	-231,5	1,4	-409,17	-362,50
	3	-228	-5,5	-471,67	-288,33
Barra 13	1	-240	-8,6	-256,67	-543,33
	2	-181,5	0,73	-314,67	-290,33
	3	-123	-6,6	-95,00	-315,00
Barra 17	1	12	-5	103,33	-63,33
	2	22,05	11,3	-151,58	225,08
	3	32,1	5	136,83	-29,83
Barra 34	1	-192	-0,78	-307,00	-333,00
	2	-199	-5,5	-240,00	-423,33
Barra 27	1	-250	-4,4	-343,33	-490,00
	2	-257	1,2	-448,33	-408,33
Barra 22	1	-150	-6,2	-146,67	-353,33
	2	-186	1,8	-340,00	-280,00
	3	-222	-6,8	-256,67	-483,33
Barra 18	1	35,6	-5	142,67	-24,00
	2	25,65	11,3	-145,58	231,08
	3	15,7	-5	109,50	-57,17

Galeria Central Ascendente

	Nós	Esforços		Tensão Actuante (kPa)	
		N (kN)	M (kN.M)	Extradorso	Intradorso
Barra 35	1	-194	-6,9	-208,33	-438,33
	2	-188	-0,86	-299,00	-327,67
Barra 42	1	-234	1,2	-410,00	-370,00
	2	-229	-3,2	-328,33	-435,00
Barra 47	1	-192	-3,5	-261,67	-378,33
	2	-159	0,54	-274,00	-256,00
	3	-126	-2,6	-166,67	-253,33
Barra 51	1	-16,8	1,4	-51,33	-4,67
	2	-11,2	8,5	-160,33	123,00
	3	-5,6	1,8	-39,33	20,67
Barra 52	1	-4	1,8	-36,67	23,33
	2	-9,65	8,6	-159,42	127,25
	3	-15,3	1,6	-52,17	1,17
Barra 56	1	-120	-3,4	-143,33	-256,67
	2	-152,5	-0,8	-240,83	-267,50
	3	-185	-5,5	-216,67	-400,00
Barra 61	1	-226	-2,5	-335,00	-418,33
	2	-232	0,05	-387,50	-385,83
Barra 68	1	-204	-0,5	-331,67	-348,33
	2	-211	-5,3	-263,33	-440,00

Galeria Central Ascendente

	Nós	Esforços		Tensão Actuante (kPa)	
		N (kN)	M (kN.M)	Extradorso	Intradorso
Barra 35	1	-187	-6,3	-206,67	-416,67
	2	-181	-0,78	-288,67	-314,67
Barra 42	1	-228	1,2	-400,00	-360,00
	2	-223	-3,1	-320,00	-423,33
Barra 47	1	-189	-3,5	-256,67	-373,33
	2	-156,5	0,48	-268,83	-252,83
	3	-124	-2,6	-250,00	-163,33
Barra 51	1	-17,3	1,2	-48,83	-8,83
	2	-11,75	8,3	-157,92	118,75
	3	-6,2	1,6	-37,00	16,33
Barra 52	1	-4,2	1,6	-33,67	19,67
	2	-9,8	8,5	-158,00	125,33
	3	-15,4	1,5	-50,67	-0,67
Barra 56	1	-116	-3,3	-138,33	-248,33
	2	-148,5	-0,5	-239,17	-255,83
	3	-181	-4,9	-220,00	-383,33
Barra 61	1	-222	-2,4	-330,00	-410,00
	2	-227	0,19	-381,50	-375,17
Barra 68	1	-203	-0,5	-330,00	-346,67
	2	-209	-5,7	-253,33	-443,33

Secção 0+720m

vs= 0,3 m
 vi= 0,3 m
 b= 1 m
 h= 0,6 m
 I= 0,018 m⁴
 A= 0,6 m²

COMBINAÇÃO ELU

Galeria Ascendente					
	Nós	Esforços		Tensão Actuante (kPa)	
		N (kN)	M (kN.M)	Extradorso	Intradorso
Barra 1	1	-4516	-360	-1526,67	-13526,67
	2	-4503	-89,6	-6011,67	-8998,33
Barra 6	1	-4578	117	-9580,00	-5680,00
	2	-4564	-114	-3806,67	-9506,67
Barra 12	1	-3477	-170	-5625,00	-8628,33
	2	-3248	71,9	-6611,67	-4215,00
	3	-3019	-102	-5031,67	-6731,67
Barra 16	1	-1436	138	-4693,33	-93,33
	2	-1420	185	-5450,00	716,67
	3	-1404	157	-4956,67	276,67
Barra 17	1	-1375	157	-4908,33	325,00
	2	-1391	193	-5535,00	898,33
	3	-1407	155	-4928,33	238,33
Barra 21	1	-2877	-22	-4795,00	-5161,67
	2	-3106,5	-1	-5177,50	-5194,17
	3	-3336	-109	-5560,00	-7376,67
Barra 27	1	-4898	-224	-8163,33	-11896,67
	2	-4912	8	-8320,00	-8053,33
Barra 32	1	-4514	115	-9440,00	-5606,67
	2	-4527	181	-10561,67	-4528,33

COMBINAÇÃO ELU

Galeria Ascendente					
	Nós	Esforços		Tensão Actuante (kPa)	
		N (kN)	M (kN.M)	Extradorso	Intradorso
Barra 1	1	-4447	-375	-1161,67	-13661,67
	2	-4433	-94,3	-5816,67	-8960,00
Barra 6	1	-4501	122	-9535,00	-5468,33
	2	-4488	-105	-5730,00	-9230,00
Barra 12	1	-3490	-172	-2950,00	-8683,33
	2	-3260,5	-75,8	-4170,83	-6697,50
	3	-3031	-108	-3251,67	-6851,67
Barra 16	1	-1494	129	-4640,00	-340,00
	2	-1478	177	-5413,33	486,67
	3	-1462	150	-4936,67	63,33
Barra 17	1	-1428	150	-4880,00	120,00
	2	-1443,5	186	-5505,83	694,17
	3	-1459	148	-4898,33	35,00
Barra 21	1	-2870	-20	-4450,00	-5116,67
	2	-3099,5	4	-5232,50	-5099,17
	3	-3329	-104	-3815,00	-7281,67
Barra 27	1	-4906	-220	-4510,00	-11843,33
	3	-4919	12	-8398,33	-7998,33
Barra 32	1	-4568	103	-9330,00	-5896,67
	2	-4581	147	-10085,00	-5185,00

Galeria Central Ascendente

	Nós	Esforços		Tensão Actuante (kPa)	
		N (kN)	M (kN.M)	Extradorso	Intradorso
Barra 33	1	-7430	-782	650,00	-25416,67
	2	-7423	-457	-4755,00	-19988,33
Barra 39	1	-7188	176	-14913,33	-9046,67
	2	-7177	-166	-9195,00	-14728,33
Barra 49	1	-5177	-98	-6995,00	-10261,67
	2	-5001,5	-20	-8002,50	-8669,17
	3	-4826	-142	-5676,67	-10410,00
Barra 55	1	-3044	108	-6873,33	-3273,33
	2	-3012,5	165	-7770,83	-2270,83
	3	-2981	10	-5135,00	-4801,67
Barra 56	1	-2987	10	-5145,00	-4811,67
	2	-3016,5	150	-7527,50	-2527,50
	3	-3046	103	-6793,33	-3360,00
Barra 62	1	-4874	-137	-5840,00	-10406,67
	2	-5049	-49,4	-7591,67	-9238,33
	3	-5224	-130	-6540,00	-10873,33
Barra 72	1	-6515	-107	-9075,00	-12641,67
	2	-6526	206	-14310,00	-7443,33
Barra 77	1	-6589	-337	-5365,00	-16598,33
	2	-6596	-622	-626,67	-21360,00

Galeria Central Ascendente

	Nós	Esforços		Tensão Actuante (kPa)	
		N (kN)	M (kN.M)	Extradorso	Intradorso
Barra 33	1	-7477	-749	21,67	-24945,00
	2	-7470	-436	-5183,33	-19716,67
Barra 39	1	-7201	174	-14901,67	-9101,67
	2	-7270	-173	-9233,33	-15000,00
Barra 49	1	-5261	-100	-7101,67	-10435,00
	2	-5085,5	-20	-8142,50	-8809,17
	3	-4910	-143	-5800,00	-10566,67
Barra 55	1	-3042	111	-6920,00	-3220,00
	2	-3010,5	169	-7834,17	-2200,83
	3	-2979	18	-5265,00	-4665,00
Barra 56	1	-2981	18	-5268,33	-4668,33
	2	-3010,5	155	-7600,83	-2434,17
	3	-3040	107	-6850,00	-3283,33
Barra 62	1	-4946	-133	-6026,67	-10460,00
	2	-5121	-46	-7768,33	-9301,67
	3	-5296	-126	-6726,67	-10926,67
Barra 72	1	-6747	-118	-9278,33	-13211,67
	2	-6758	205	-14680,00	-7846,67
Barra 77	1	-6810	-322	-5983,33	-16716,67
	2	-6817	-618	-1061,67	-21661,67

COMBINAÇÃO FREQUENTE					
Galeria Ascendente					
	Nós	Esforços		Tensão Actuante (kPa)	
		N (kN)	M (kN.M)	Extradorso	Intradorso
Barra 1	1	-3211	-302	-318,33	-10385,00
	2	-3202	-78,7	-4025,00	-6648,33
Barra 6	1	-3228	92,1	-6915,00	6915,00
	2	-3218	-71,9	-4165,00	-6561,67
Barra 12	1	-2494	-125	6240,00	-6240,00
	2	-2324	-54,5	-2965,00	-4781,67
	3	-2154	-78,6	-2280,00	-4900,00
Barra 16	1	-1047	93,6	-3305,00	-185,00
	2	-1035	129	-3875,00	425,00
	3	-1023	108	-3505,00	95,00
Barra 17	1	-1000	108	-3466,67	133,33
	2	-1011,5	135	-3935,83	564,17
	3	-1023	107	-3488,33	78,33
Barra 21	1	-2043	-18	-3105,00	-3705,00
	2	-2213	0,5	-3696,67	-3680,00
	3	-2383	-77,9	-2673,33	-5270,00
Barra 27	1	-3485	-160	-3141,67	-8475,00
	2	-3495	5	-5908,33	-5741,67
Barra 32	1	-3201	83,8	-6731,67	-3938,33
	2	-3211	136	-7618,33	-3085,00

COMBINAÇÃO FREQUENTE					
Galeria Ascendente					
	Nós	Esforços		Tensão Actuante (kPa)	
		N (kN)	M (kN.M)	Extradorso	Intradorso
Barra 1	1	-3187	-308	-178,33	-10445,00
	2	-3177	-80,7	-3950,00	-6640,00
Barra 6	1	-3199	93,4	-6888,33	6888,33
	2	-3189	-69,4	-4158,33	-6471,67
Barra 12	1	-2487	-125	6228,33	-6228,33
	2	-2317	-55,1	-2943,33	-4780,00
	3	-2147	-79,6	-2251,67	-4905,00
Barra 16	1	-1053	91,4	-3278,33	-231,67
	2	-1041	127	-3851,67	381,67
	3	-1029	106	-3481,67	51,67
Barra 17	1	-1005	106	-3441,67	91,67
	2	-1016,5	133	-3910,83	522,50
	3	-1028	105	-3463,33	36,67
Barra 21	1	-2032	-18	-3086,67	-3686,67
	2	-2202	1,2	-3690,00	-3650,00
	3	-2372	-76,7	-2675,00	-5231,67
Barra 27	1	-3470	-158	-3150,00	-8416,67
	2	-3480	6	-5900,00	-5700,00
Barra 32	1	-3193	82	-6688,33	-3955,00
	2	-3203	131	-7521,67	-3155,00

Galeria Central Ascendente					
	Nós	Esforços		Tensão Actuante (kPa)	
		N (kN)	M (kN.M)	Extradorso	Intradorso
Barra 33	1	-5368	-580	720,00	-18613,33
	2	-5363	-340	-3271,67	-14605,00
Barra 39	1	-5187	131	-10828,33	-6461,67
	2	-5179	-117	-6681,67	-10581,67
Barra 49	1	-3776	-74,3	-5055,00	-7531,67
	2	-130	-12	-16,67	-416,67
	3	3516	77,2	4573,33	7146,67
Barra 55	1	-2227	75	-4961,67	-2461,67
	2	-2203,5	120	-5672,50	-1672,50
	3	-2180	8	-3766,67	-3500,00
Barra 56	1	-2182	8	-3770,00	-3503,33
	2	-2204	110	-5506,67	-1840,00
	3	-2226	74,2	-4946,67	-2473,33
Barra 62	1	-3547	-101	-4228,33	-7595,00
	2	-3677	-37	-5511,67	-6745,00
	3	-3807	-96	-4745,00	-7945,00
Barra 72	1	-4735	74,2	-9128,33	-6655,00
	2	-4744	153	-10456,67	-5356,67
Barra 77	1	-4805	-256	-3741,67	-12275,00
	2	-4811	-471	-168,33	-15868,33

Galeria Central Ascendente					
	Nós	Esforços		Tensão Actuante (kPa)	
		N (kN)	M (kN.M)	Extradorso	Intradorso
Barra 33	1	-5360	-575	650,00	-18516,67
	2	-5355	-337	-3308,33	-14541,67
Barra 39	1	-5185	131	-10825,00	-6458,33
	2	-5177	-117	-6678,33	-10578,33
Barra 49	1	-3781	-71,8	-5105,00	-7498,33
	2	-3651,5	-12	-5885,83	-6285,83
	3	-3522	-74,8	-7116,67	-4623,33
Barra 55	1	-2223	77,5	-4996,67	-2413,33
	2	-2199,5	121	-5682,50	-1649,17
	3	-2176	8	-3760,00	-3493,33
Barra 56	1	-2178	8	-3763,33	-3496,67
	2	-2200	110	-5500,00	-1833,33
	3	-2222	74,7	-4948,33	-2458,33
Barra 62	1	-3551	-101	-4235,00	-7601,67
	2	-3680,5	-36	-5534,17	-6734,17
	3	-3810	-95,5	-4758,33	-7941,67
Barra 72	1	-4758	-75,4	-9186,67	-6673,33
	2	-4766	153	-10493,33	-5393,33
Barra 77	1	-4828	-256	-3780,00	-12313,33
	2	-4834	-471	-206,67	-15906,67

Secção 0+750m

vs= 0,3 m
 vi= 0,3 m
 b= 1 m
 h= 0,6 m
 I= 0,018 m⁴
 A= 0,6 m²

COMBINAÇÃO ELU Galeria Ascendente

	Nós	Esforços		Tensão Actuante (kPa)	
		N (kN)	M (kN.m)	Extradorso	Intradorso
Barra 1	1	-2310	-122	-1816,67	-5883,33
	2	-2299	-22,3	-3460,00	-4203,33
Barra 7	1	-2447	84,1	-5480,00	-2676,67
	2	-2442,5	0,1	-4072,50	-4069,17
	3	-2438	-12	-3863,33	-4263,33
Barra 14	1	-2118	-66,2	-2426,67	-4633,33
	2	-2014,5	-0,4	-3350,83	-3364,17
	3	-1911	-10	-3018,33	-3351,67
Barra 17	1	-1718	60,5	-3871,67	-1855,00
	2	-1700	106	-4600,00	-1066,67
	3	-1682	66,8	-3916,67	-1690,00
Barra 18	1	-1733	66,8	-4001,67	-1775,00
	2	-1751,5	103	-4635,83	-1202,50
	3	-1770	54,2	-3853,33	-2046,67
Barra 21	1	-2248	-22	-3380,00	-4113,33
	2	-2352	-13	-3703,33	-4136,67
	3	-2456	-74,4	-2853,33	-5333,33
Barra 28	1	-3930	80,2	-7886,67	-5213,33
	2	-3938	204	-9963,33	-3163,33
Barra 34	1	-4642	-413	-853,33	-14620,00
	2	-4658	-804	5636,67	-21163,33

COMBINAÇÃO ELU Galeria Central Ascendente

	Nós	Esforços		Tensão Actuante (kPa)	
		N (kN)	M (kN.m)	Extradorso	Intradorso
Barra 35	1	-7142	-76,7	-10625,00	-13181,67
	2	-7131	56,5	-12826,67	-10943,33
Barra 41	1	-7647	-42	-12045,00	-13445,00
	2	-7642	-205	-9320,00	-16153,33
Barra 48	1	-6094	-179	-7173,33	-13140,00
	2	-5856,5	-106	-7994,17	-11527,50
Barra 55	1	-5619	-167	-6581,67	-12148,33
	2	-2431	224	-7785,00	-318,33
Barra 56	1	-2429	152	-6581,67	-1515,00
	2	-2403	152	-6538,33	-1471,67
Barra 63	1	-2403,5	256	-8317,50	215,83
	2	-2430,5	256	-8317,50	215,83
	3	-2458	228	-7896,67	-296,67
Barra 70	1	-5618	-167	-6580,00	-12146,67
	2	-5856	-106	-7993,33	-11526,67
	3	-6094	-179	-7173,33	-13140,00
Barra 76	1	-7617	-203	-9311,67	-16078,33
	2	-7617	-58	-11728,33	-13661,67

COMBINAÇÃO FREQUENTE Galeria Ascendente

	Nós	Esforços		Tensão Actuante (kPa)	
		N (kN)	M (kN.m)	Extradorso	Intradorso
Barra 1	1	-1702	-90,9	-1321,67	-4351,67
	2	-1694	-20	-2490,00	-3156,67
Barra 7	1	-1802	84,1	-4405,00	-1601,67
	2	-1795	8,4	-3131,67	-2851,67
Barra 14	1	-1562	-49,1	-1785,00	-3421,67
	2	-1485	-0,4	-2468,33	-2481,67
	3	-1408	-8	-2213,33	-2480,00
Barra 17	1	-1268	44,4	-2853,33	-1373,33
	2	-1254,5	78,1	-3392,50	-789,17
	3	-1241	49	-2885,00	-1251,67
Barra 18	1	-1279	49	-2948,33	-1315,00
	2	-1292,5	75,9	-3419,17	-889,17
	3	-1306	39,6	-2836,67	-1516,67
Barra 21	1	-1659	-18	-2465,00	-3065,00
	2	-1736	-12	-2693,33	-3093,33
	3	-1813	-55,2	-2101,67	-3941,67
Barra 28	1	-2900	59,7	-5828,33	-3838,33
	2	-2506	151	-6693,33	-1660,00
Barra 34	1	-3426	-305	-626,67	-10793,33
	2	-3434	-595	4193,33	-15640,00

COMBINAÇÃO FREQUENTE Galeria Central Ascendente

	Nós	Esforços		Tensão Actuante (kPa)	
		N (kN)	M (kN.m)	Extradorso	Intradorso
Barra 35	1	-5295	-57,6	-7865,00	-9785,00
	2	-5286	41,2	-9496,67	-8123,33
Barra 41	1	-5648	-32	-8880,00	-9946,67
	2	-5559	-151	-6748,33	-11781,67
Barra 48	1	-4500	-132	-5300,00	-9700,00
	2	-4324	-78,6	-5896,67	-8516,67
	3	-4148	-124	-4846,67	-8980,00
Barra 55	1	-1795	166	-5758,33	-225,00
	2	-1794	112	-4856,67	-1123,33
Barra 56	1	-1774	112	-4823,33	-1090,00
	2	-1794,5	189	-6140,83	159,17
	3	-1815	168	-5825,00	-225,00
Barra 63	1	-4148	-123	-4863,33	-8963,33
	2	-4324	-78,4	-5900,00	-8513,33
	3	-4500	-132	-5300,00	-9700,00
Barra 70	1	-5626	-39	-8726,67	-10026,67
	2	-5626	106	-7610,00	-11143,33
Barra 76	1	-5266	40,4	-9450,00	-8103,33
	2	-5274	-57	-9740,00	-7840,00